

# PARTS LIST

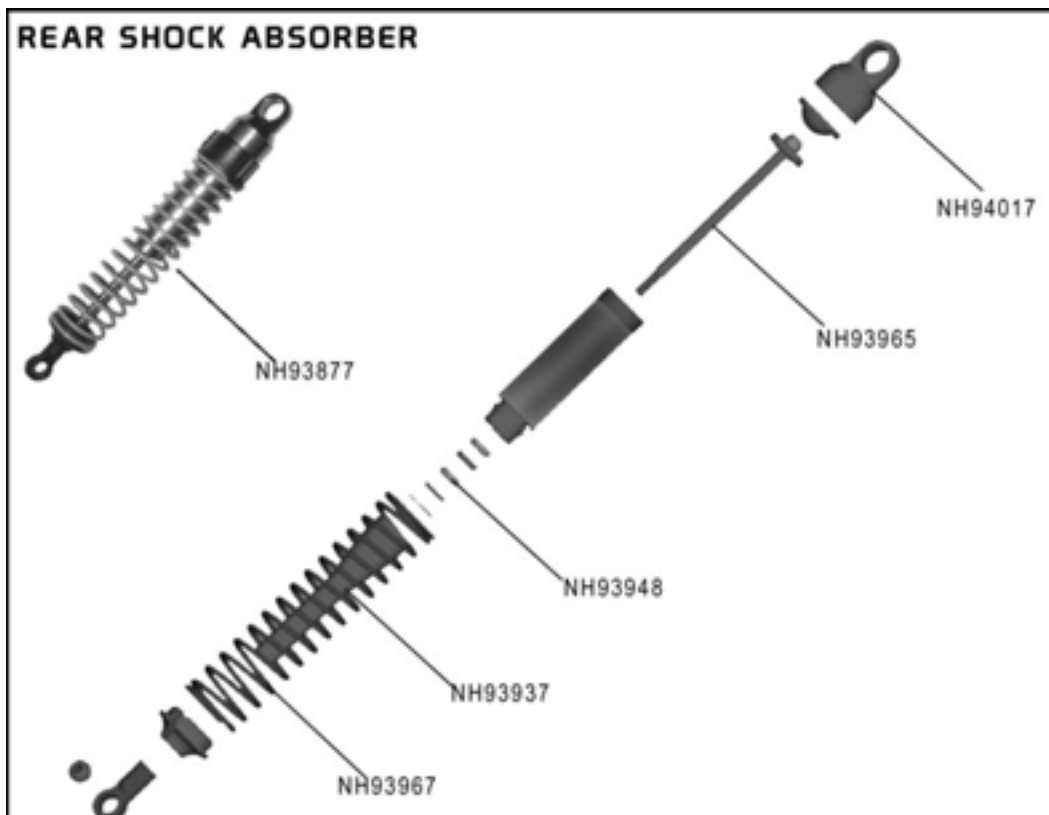

# MOTOR/AIR FILTER/EXHAUST

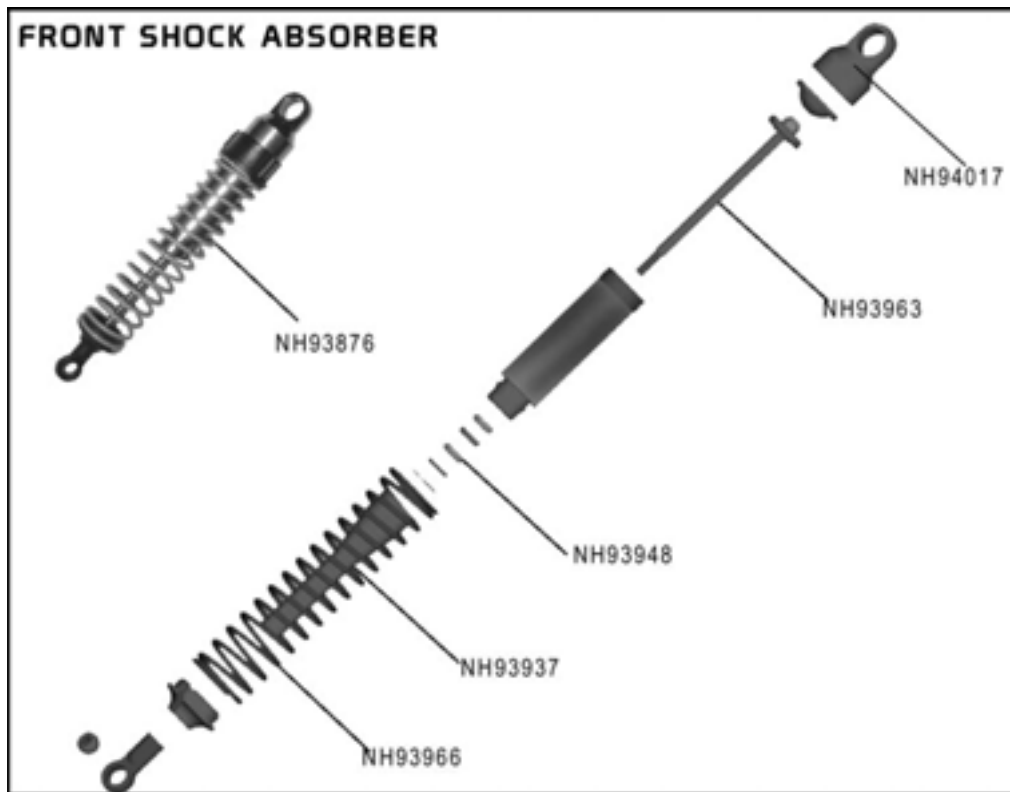
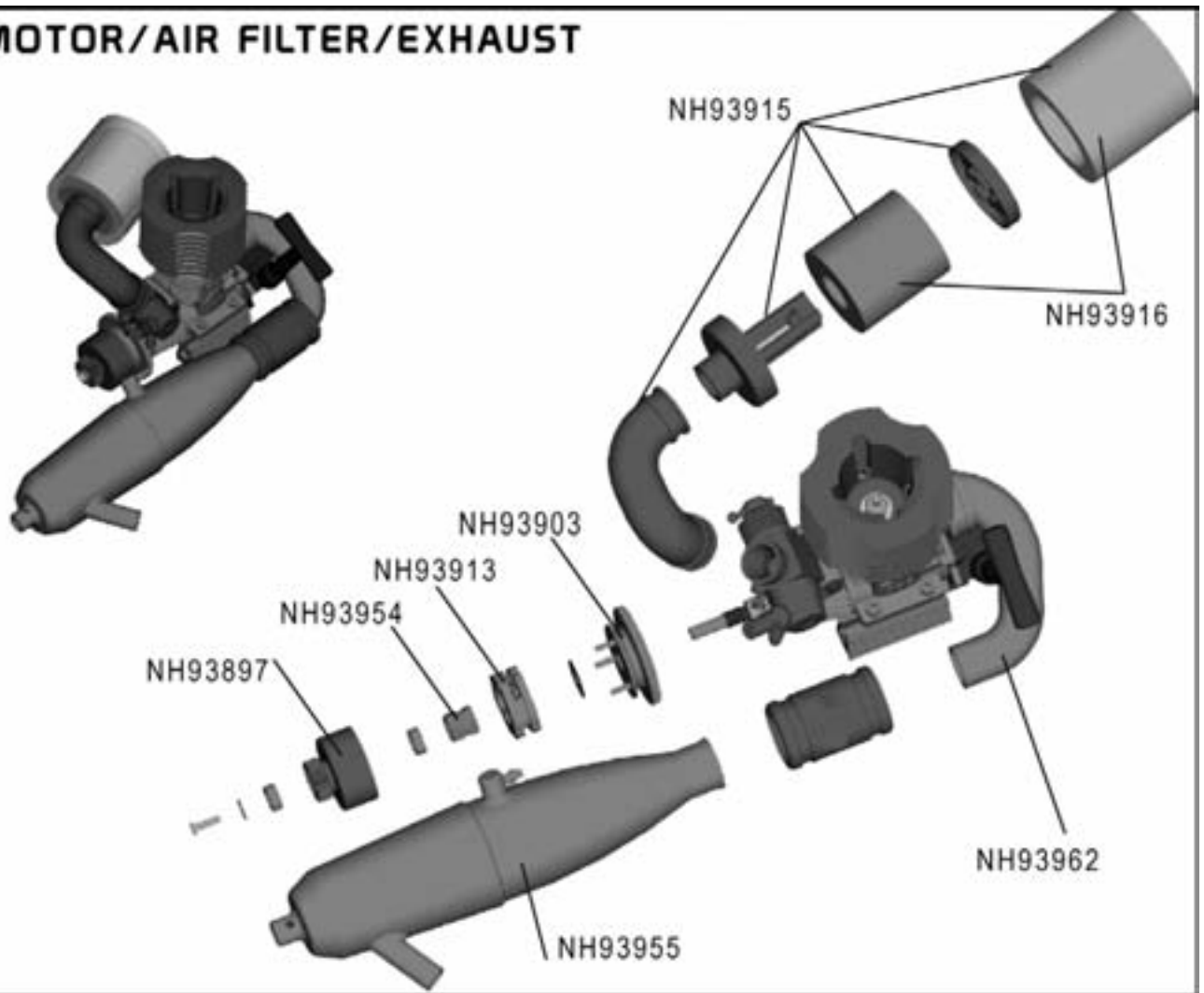

# SERVO/RECEIVER BOX

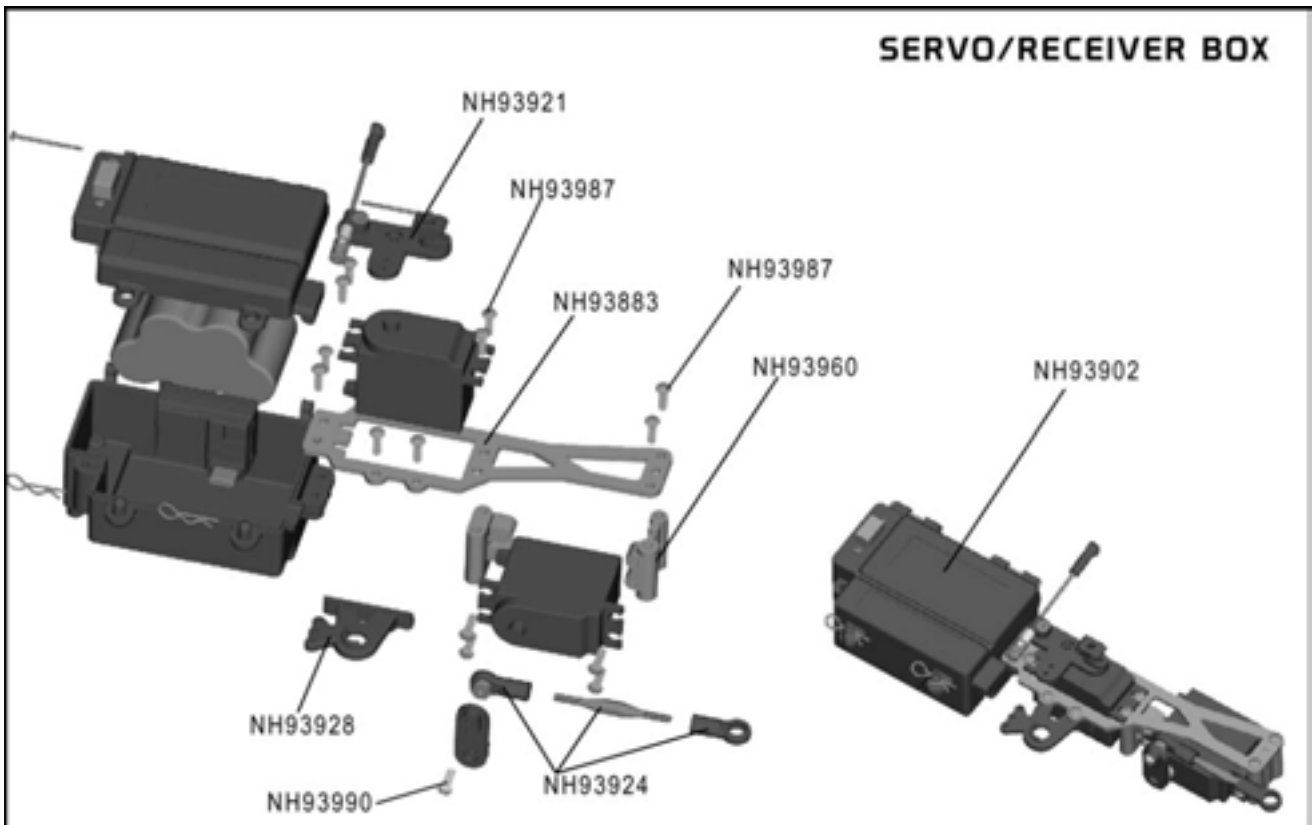

## FUEL TANK

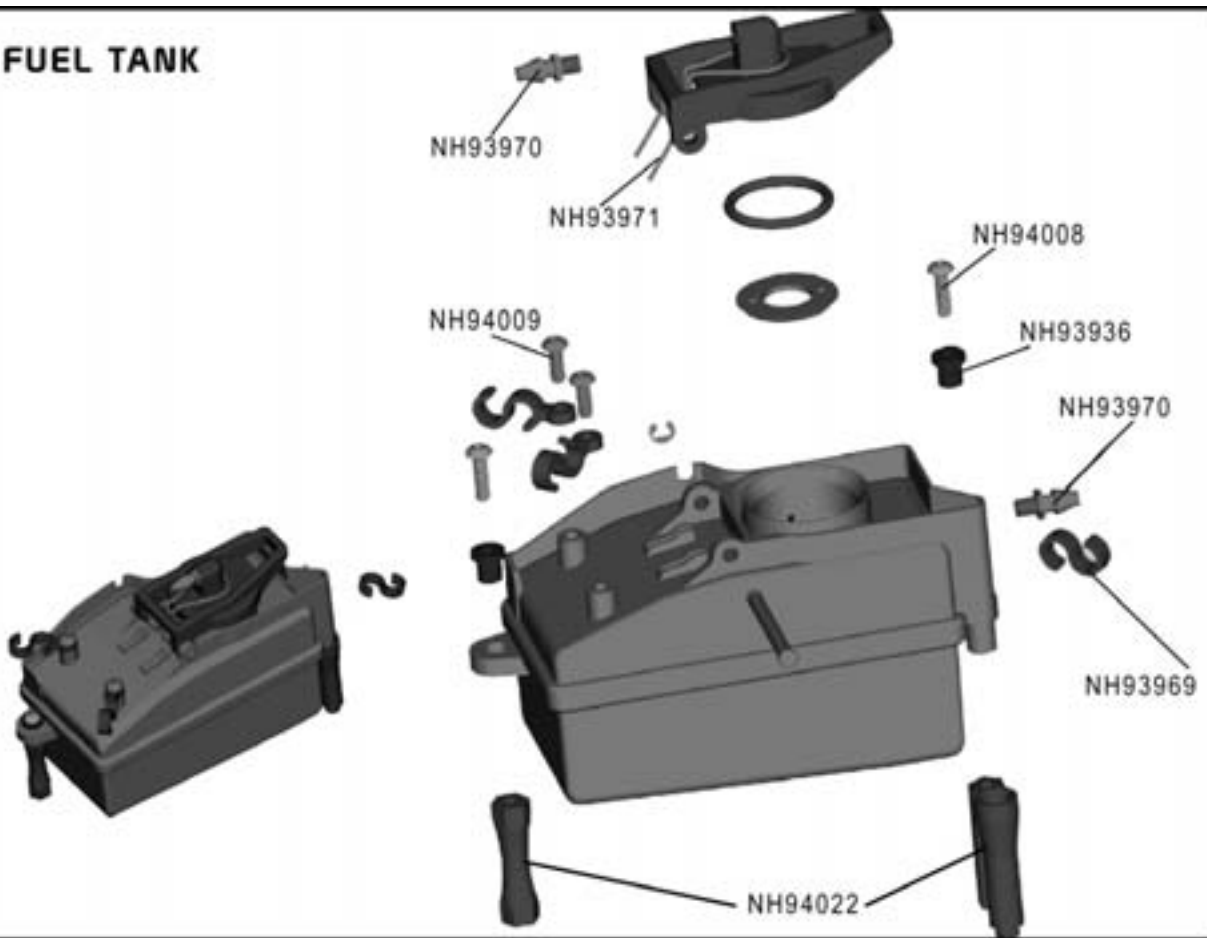

## FRONT GEAR BOX

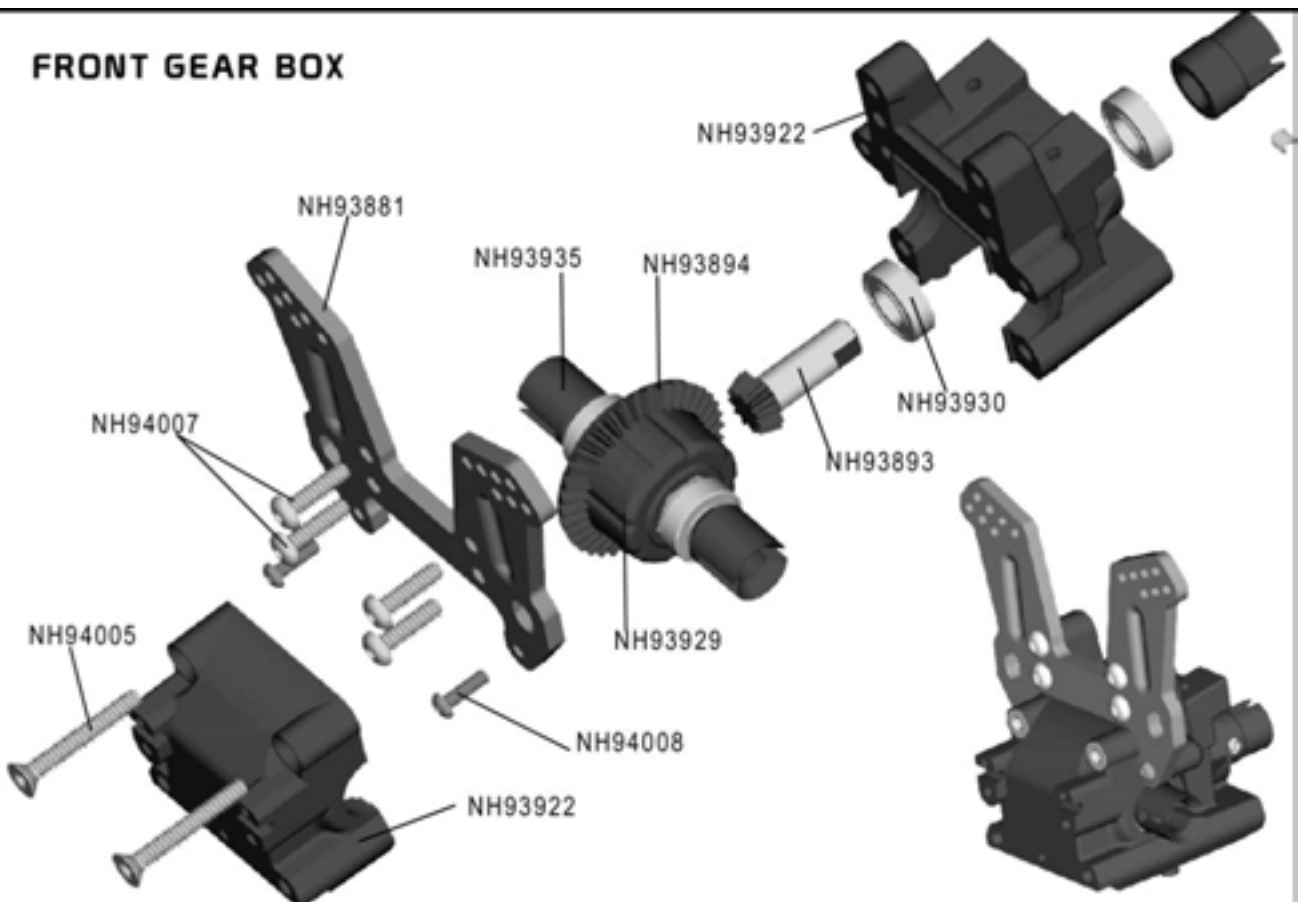

## FRONT/REAR DIFFERENTIAL

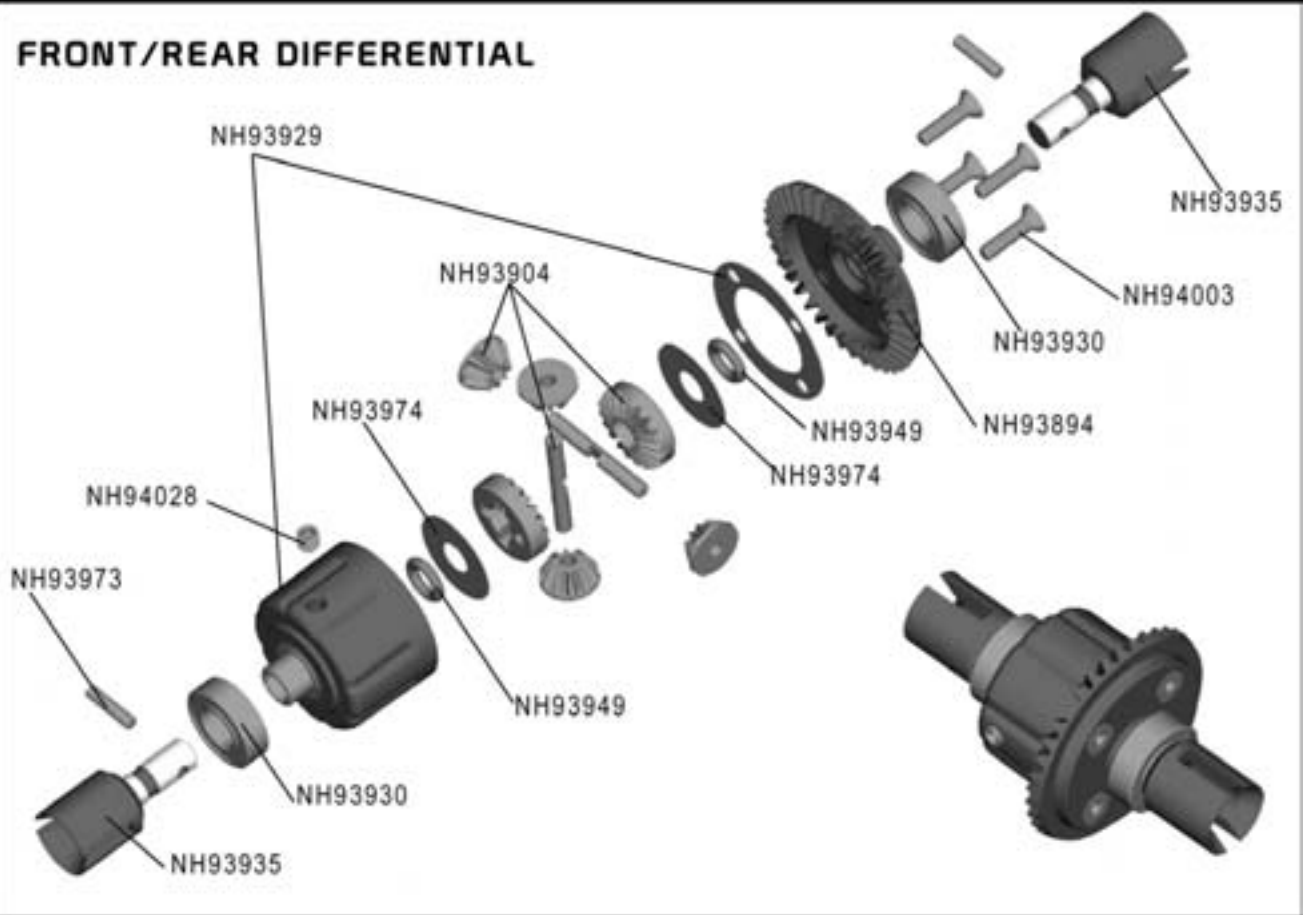

## CENTER DIFFERENTIAL

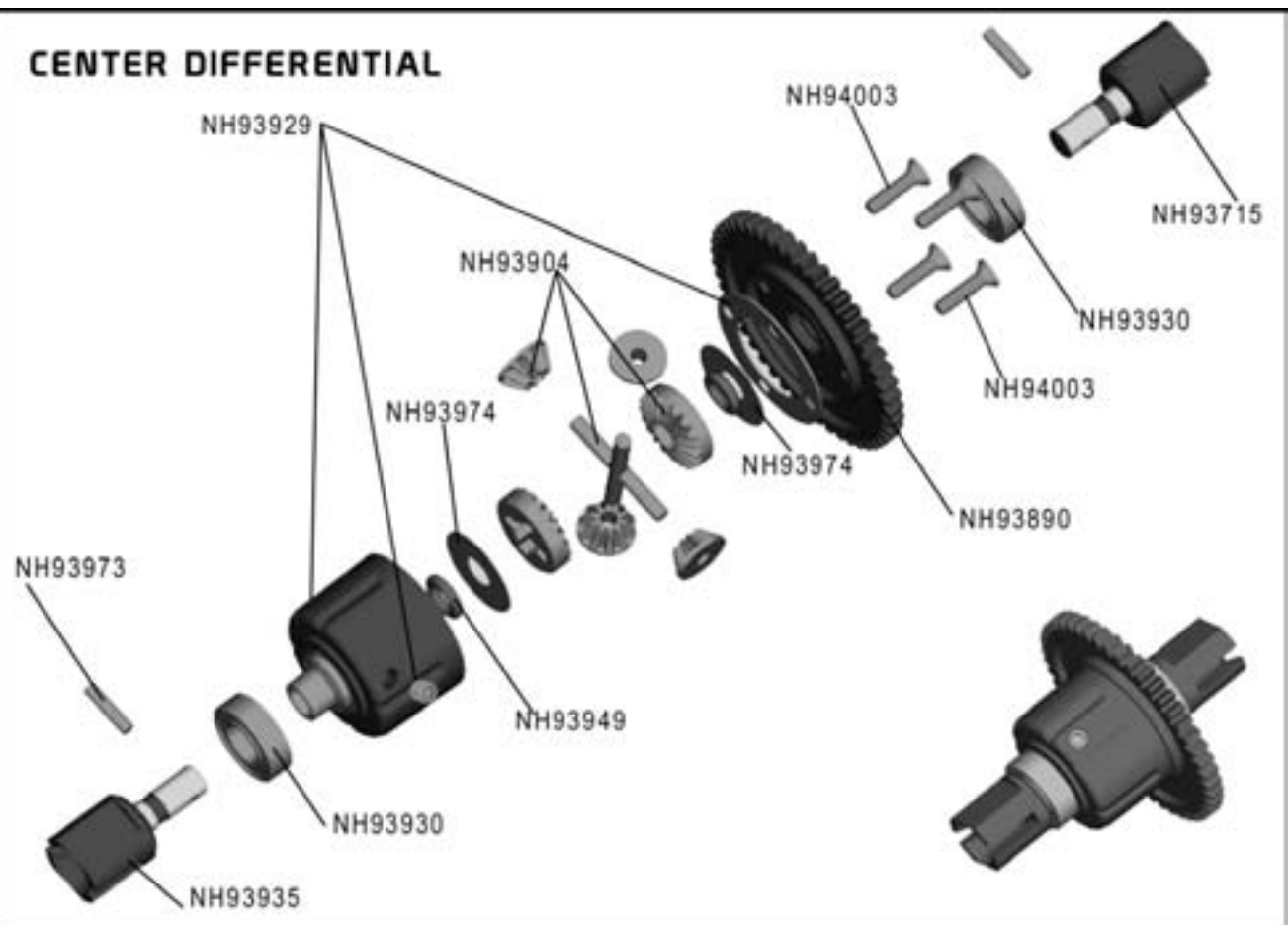

### STEERING HUB

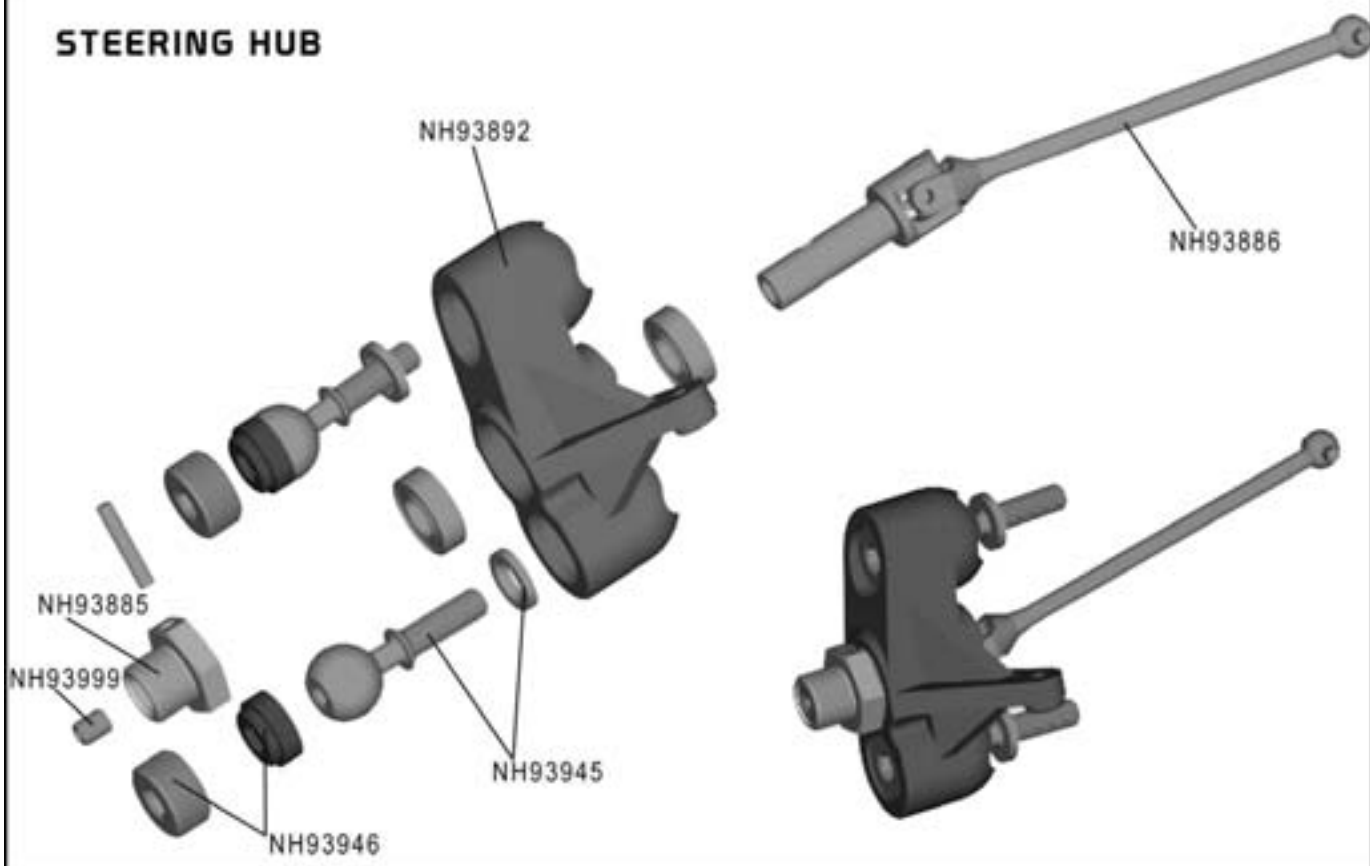

### STEERING ARM

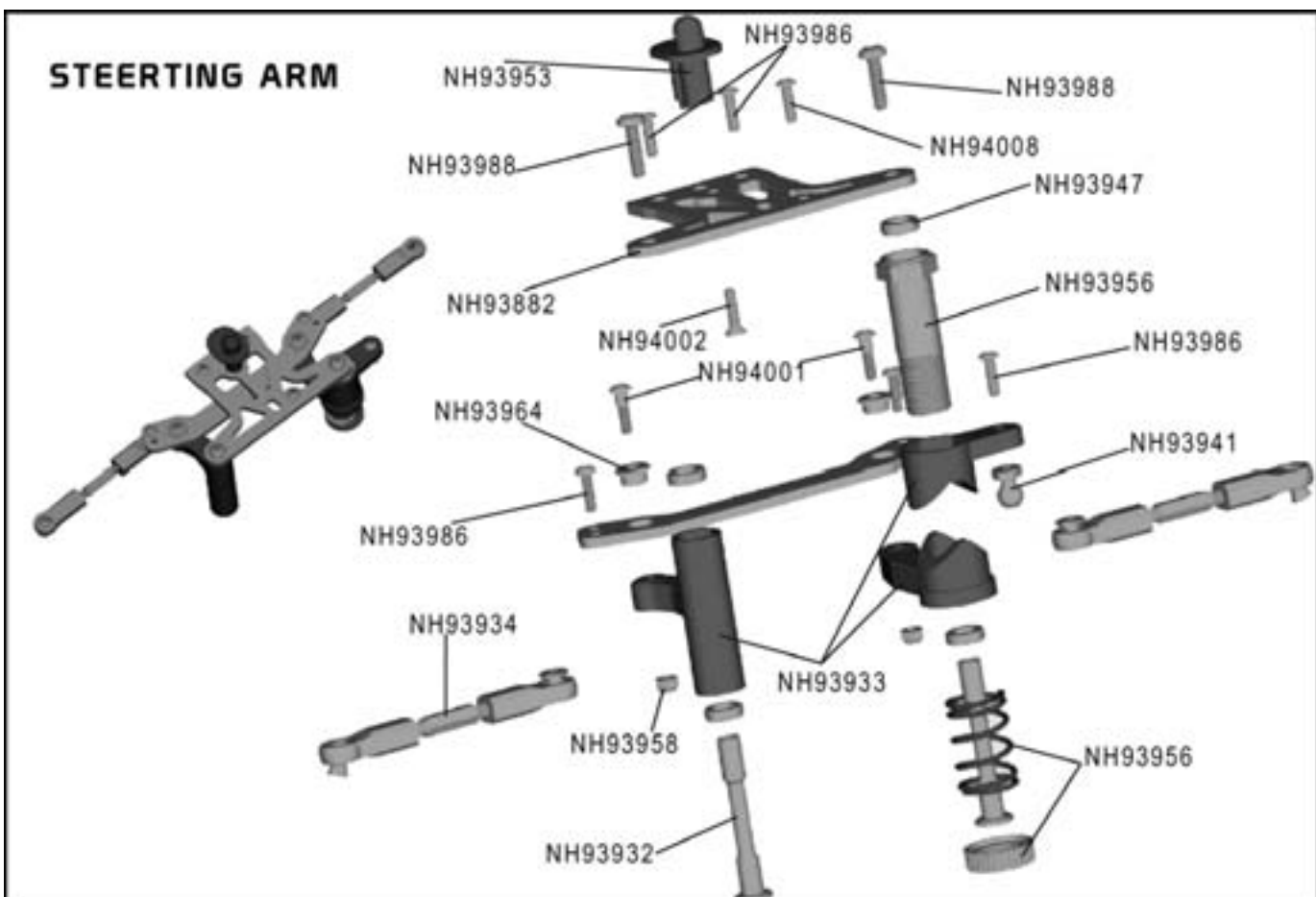

### CENTER DIFFERENTIAL

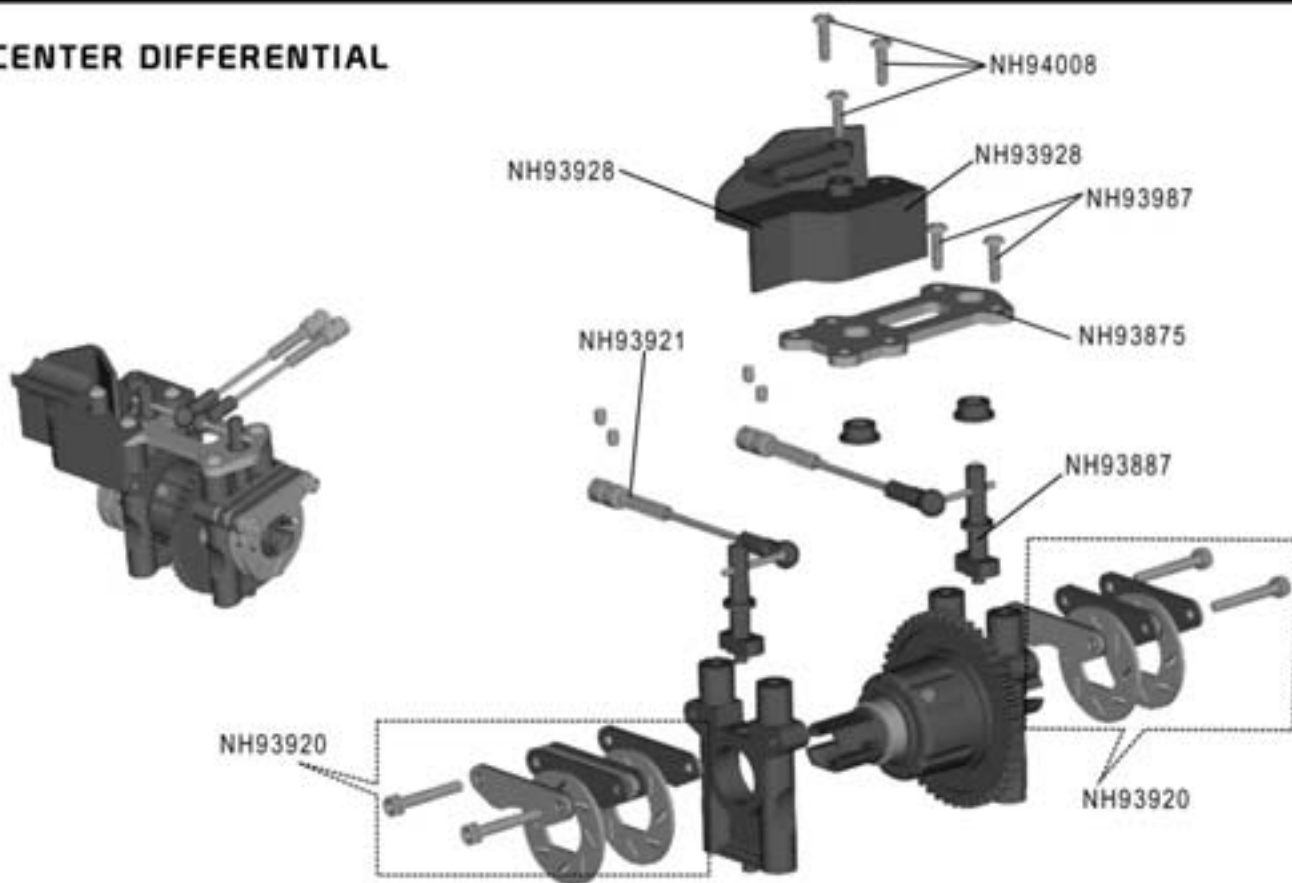

### WING

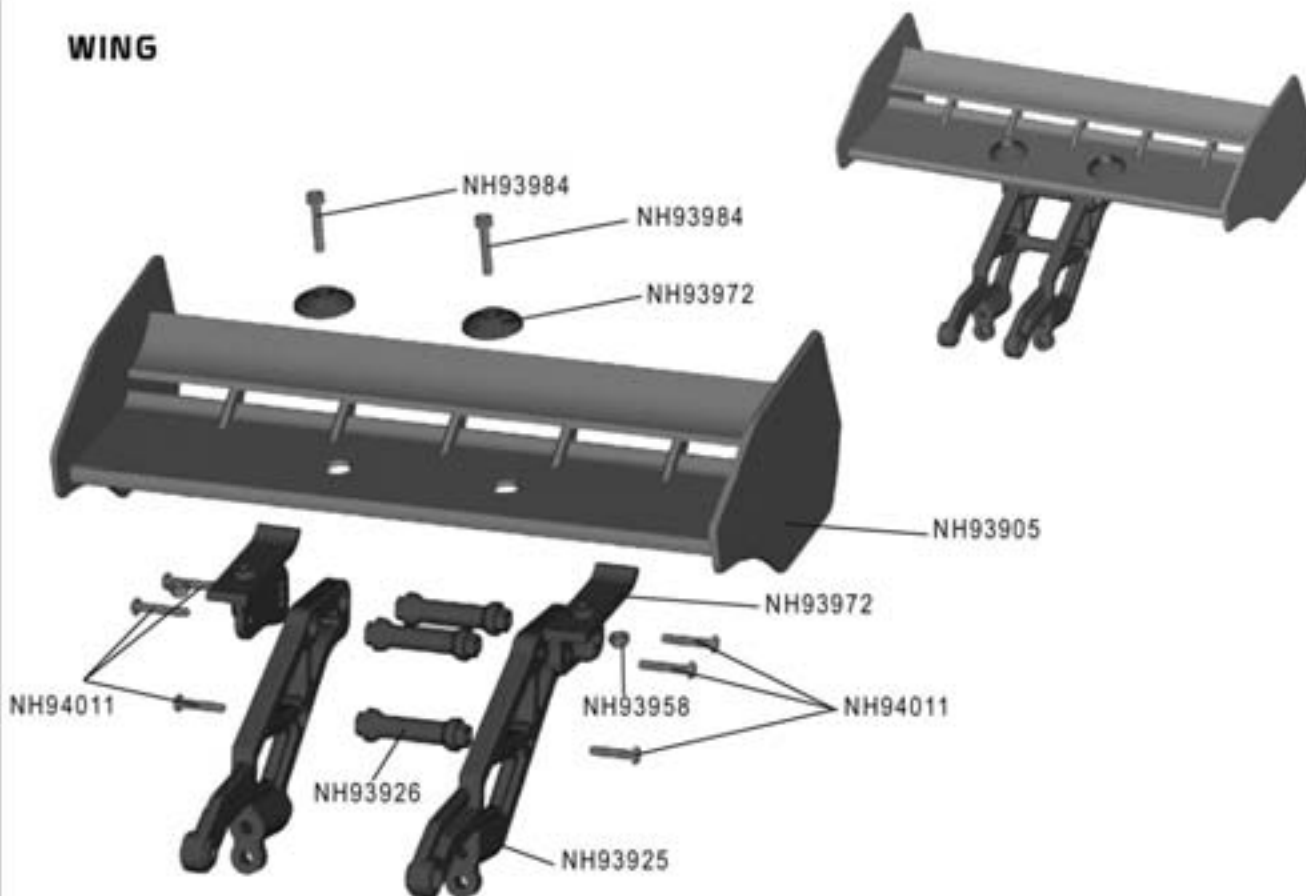

# FRONT UNIT

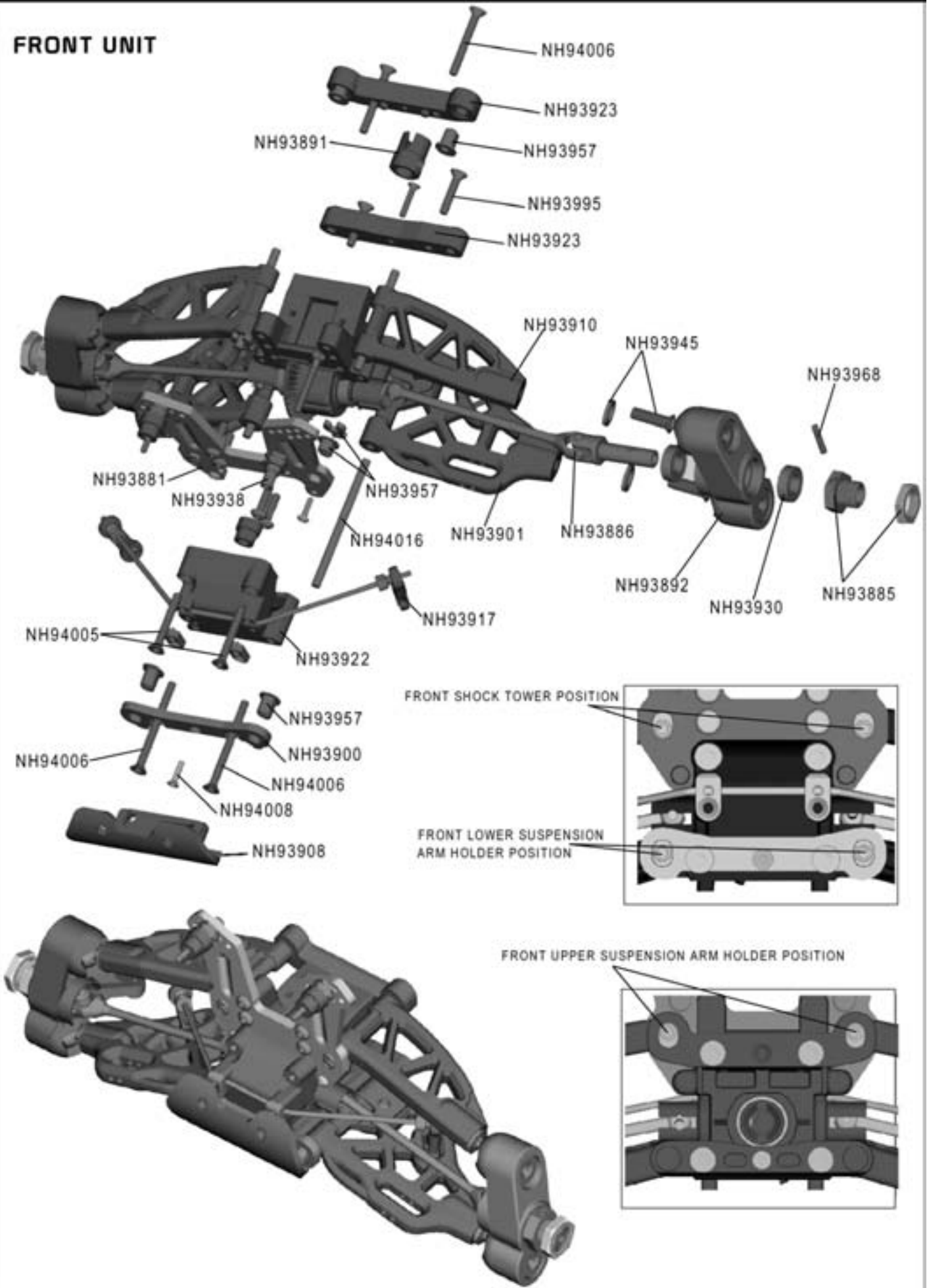

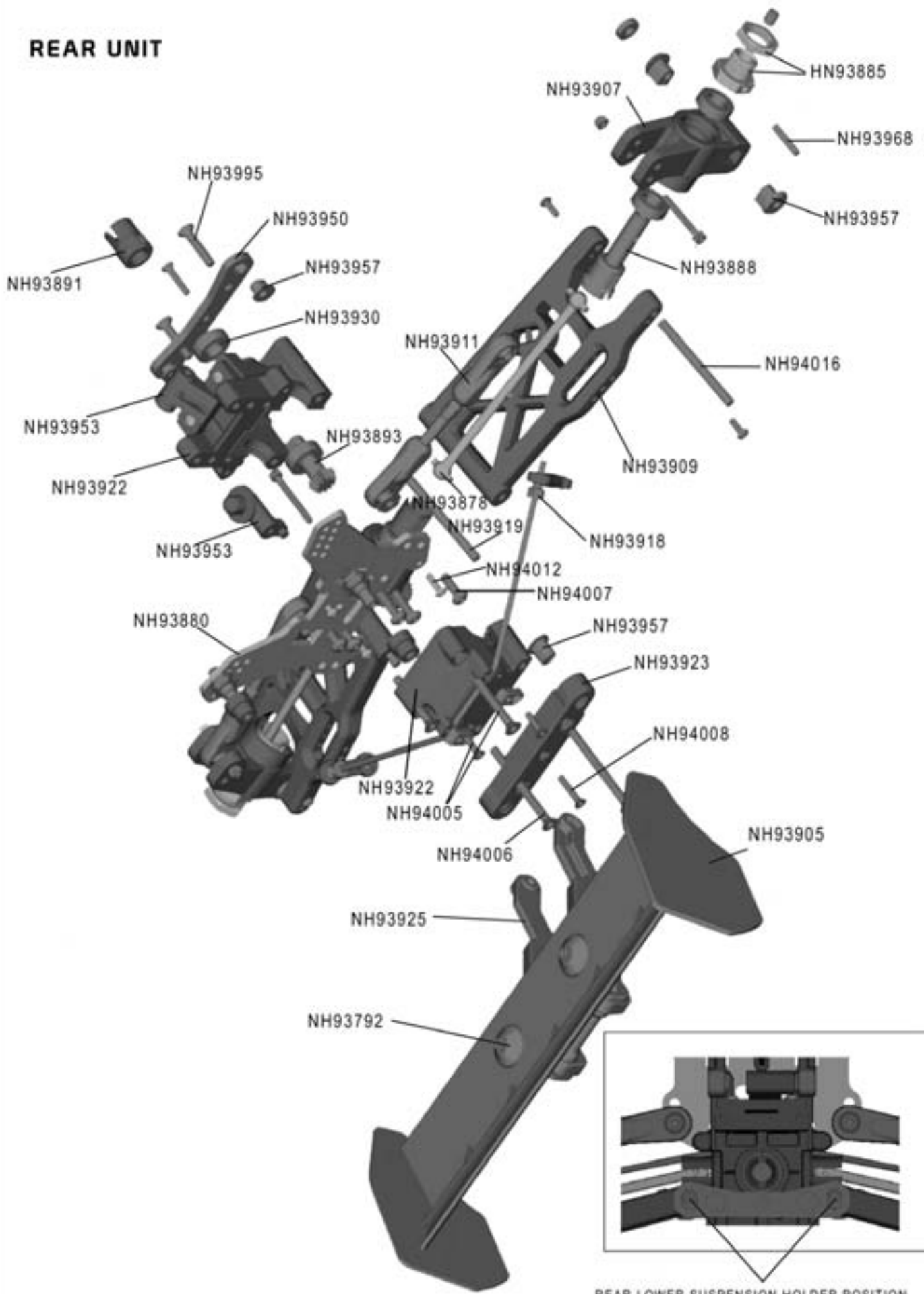

# REAR UNIT











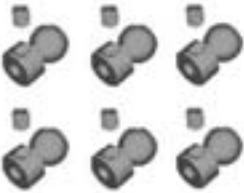
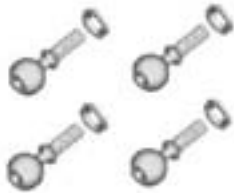





















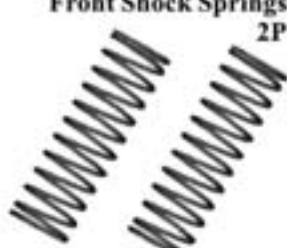













REAR LOWER SUSPENSION HOLDER POSITION























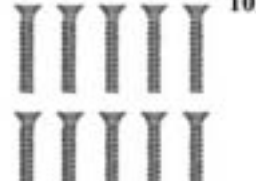

<p>NH93876 <b>Front Shock Absorber</b> 2P</p> 	<p>NH93877 <b>Rear Shock Absorber</b> 2P</p> 	<p>NH93882 <b>Front Top Plate</b></p> 	<p>NH93884 <b>Steering Ackerman Plate</b></p> 
<p>NH93885 <b>Wheel Hex.+ Nuts</b> 2P</p> 	<p>NH93887 <b>Brake Cams</b> 2P</p> 	<p>NH93888 <b>Rear Axles</b> 2P</p> 	<p>NH93889 <b>Center Diff.Joint Cups</b> 2P</p> 
<p>NH93891 <b>Drive Cups</b> 2P</p> 	<p>NH93892 <b>Front Hubs (L/R)</b></p> 	<p>NH93893 <b>Diff. Pinions</b> 2P</p> 	<p>NH93894 <b>Diff. Gear</b></p> 
<p>NH93896 <b>Engine Holder/ Mount</b></p> 	<p>NH93898 <b>Switch Housing</b> 2P</p> 	<p>NH93899 <b>Center Diff. Mount</b> 2P</p> 	<p>NH93746 <b>Transmitter 2,4Ghz</b></p> 
<p>NH93900 <b>Front Lower Suspension Arm Holder</b></p> 	<p>NH93902 <b>Battery/Receiver Box</b></p> 	<p>NH93903 <b>Engine Flywheel</b></p> 	<p>NH93747 <b>Receiver 2,4Ghz</b></p> 
<p>NH93904 <b>Diff.Gears+Pins</b></p> 	<p>NH93907 <b>Rear Uprights</b> 2P</p> 	<p>NH93912 <b>Shock Cup Tension Clips</b> 12P</p> 	<p>NH93913 <b>Clutch Shoes +Springs</b> 3P</p> 









<p>NH93915 <b>Air Fuel Complete</b></p> 	<p>NH93916 <b>Air Fuel Sponges 2P</b></p> 	<p>NH93919 <b>Front Upper inside Hinge Pins 51mm 2P &amp; Rear Lower Outside Hinge Pins 49.5mm 2P</b></p> 	<p>NH93920 <b>Brake Discs+Pads</b></p> 
	<p>NH93921 <b>Servo Linkage Complete</b></p> 	<p>NH93922 <b>Gear Box</b></p> 	<p>NH93923 <b>Suspension Holders</b></p> 
<p>NH93924 <b>Servo Link</b></p> 	<p>NH93928 <b>Fuel Filter Holder +Splash Guard</b></p> 	<p>NH93929 <b>Differential Case</b></p> 	<p>NH93930 <b>Bearings 16*8*5 8P</b></p> 
<p>NH93931 <b>Exhaust Pipe Holder</b></p> 	<p>NH93932 <b>Steering Posts 2P</b></p> 	<p>NH93933 <b>Steering Arms</b></p> 	<p>NH93935 <b>Diff.Cups (front/Rear) 2P</b></p> 
<p>NH93936 <b>Fuel Tank Bushes</b></p> 	<p>NH93937 <b>Shock Boots (front 2P+ rear 2P)</b></p> 	<p>NH93938 <b>Shock Posts 4P</b></p> 	<p>NH93939 <b>Rear Upper Arm Balls A 6P</b></p> 
<p>NH93940 <b>Rear Upper Arm Balls B 6P</b></p> 	<p>NH93941 <b>Steering Link Balls B 6P</b></p> 	<p>NH93942 <b>Steering Link Balls A 6P</b></p> 	<p>NH93943 <b>Shock Balls 6P</b></p> 

<p>NH93944 <b>Sway Bar Balls</b> 6P</p> 	<p>NH93945 <b>Front Suspension Arm Balls</b> 4P</p> 	<p>NH93946 <b>Front Hub Caps</b> 4P</p> 	<p>NH93947 <b>Steering Post Bushings</b> 4P</p> 
<p>NH93948 <b>Shock Seals</b> 8P</p> 	<p>NH93949 <b>Differential Seals</b> 6P</p> 	<p>NH93950 <b>Rear Lower Suspension Arm Holder</b></p> 	<p>NH93951 <b>Front Brace</b></p> 
<p>NH93952 <b>Rear Brace</b></p> 	<p>NH93953 <b>Body Post</b></p> 	<p>NH93954 <b>Engine Flywheel Nut</b> 2P</p> 	<p>NH94037 PAINTED BODY STAMPER</p>
<p>NH93955 <b>Tuned Pipe</b></p> 	<p>NH93956 <b>Servo Saver /Spring</b></p> 	<p>NH93957 <b>Adjustable Bushes Complete</b></p> 	<p>NH94038 CLEAR BODY STAMPER</p>
<p>NH93958 <b>Nylon Nuts M3</b> 6P</p> 	<p>NH93959 <b>Nylon Nuts M4</b> 8P</p> 	<p>NH93960 <b>Radio Plate Posts</b></p> 	<p>NH93961 <b>Ball Ends</b></p> 
<p>NH93962 <b>Mainfold</b></p> 	<p>NH93963 <b>Front Shock Shafts +Pistons</b> 2P</p> 	<p>NH93964 <b>Steering Plate Bushes</b></p> 	<p>NH93965 <b>Rear Shock Shafts +Pistons</b> 2P</p> 

<p>NH93966 <b>Front Shock Springs</b> 2P</p> 	<p>NH93967 <b>Rear Shock Springs</b> 2P</p> 	<p>NH93968 <b>Shaft Pins</b> 2P</p> 	<p>NH93969 <b>Fuel Pipe Holder</b></p> 
<p>NH93970 <b>Fuel Inlets</b> 2P</p> 	<p>NH93971 <b>Fuel Tank Spring</b></p> 	<p>NH93972 <b>Adjustable Wing Mount</b> 2P</p> 	<p>NH93973 <b>Diff. Gear Pins</b> 3P</p> 
<p>NH93974 <b>Washer 17*6.2*0.3</b> 6P (For Differentials Mount)</p> 	<p>NH93975 <b>Washer 16*13.1*0.3</b> 6P (For Gear Box Bearing Mount)</p> 	<p>NH93976 <b>Washer 8*5.2*0.3</b> 6P (For Engine Crank Mount)</p> 	<p>NH93977 <b>Washer 6.5*3.0*0.5</b> 6P (For Shock Shaft)</p> 
<p>NH93978 <b>Washer 8*3.2*0.5</b> 6P (For shock balls Mount)</p> 	<p>NH93979 <b>Washer 7.0*2.6*0.4</b> 6P (For Flywheel Pin Mount)</p> 	<p>NH93980 <b>Washer 4.2*10*1.0</b> 6P (For Engine Mount)</p> 	<p>NH93981 <b>Cap Head Hex. Screws</b> 4*10 8P</p> 
<p>NH93982 <b>Cap Head Screws</b> 4*26 4P</p> 	<p>NH93983 <b>Cap Head Screws</b> 3*14 8P</p> 	<p>NH93984 <b>Cap Head Screws</b> 3*16 6P</p> 	<p>NH93985 <b>Cap Head Screw</b> 3*20 4P</p> 
<p>NH93986 <b>Button Head Screws</b> 3*12 10P</p> 	<p>NH93987 <b>Button Head Screws</b> 3*10 10P</p> 	<p>NH93988 <b>Button Head Screws</b> 4*12 8P</p> 	<p>NH93989 <b>Button Head Screws</b> 4*40 4P</p> 



<p>NH93990 <b>Flat Head Screws</b> 3*10 5P</p> 	<p>NH93991 <b>Flat Head Self Tapping Screws</b> 3*16 4P</p> 	<p>NH93992 <b>Flat Head Screws</b> 3*18 3P</p> 	<p>NH93993 <b>Flat Head Screws</b> 4*10 4P</p> 
<p>NH93994 <b>Flat Head Screws</b> 4*18 12P</p> 	<p>NH93995 <b>Flat Head Self Tapping Screws</b> 4*22 4P</p> 	<p>NH93996 <b>Flat Head Self Tapping Screws</b> 4*30 4P</p> 	<p>NH93997 <b>Set Screws M3*3</b> 12P</p> 
<p>NH93998 <b>Set Screws M4*10</b> 4P</p> 	<p>NH93999 <b>Set Screws M5*4</b> 6P</p> 	<p>NH94000 <b>Ball Head Self Tapping Screws</b> 2*24 4P</p> 	<p>NH94001 <b>Steering Plate Screws</b> 6P</p> 
<p>NH94002 <b>Flat Head Self Tapping Screws</b> 3*10 12P</p> 	<p>NH94003 <b>Flat Head Self Tapping Screws</b> 3*18 10P</p> 	<p>NH94004 <b>Flat Head Screws</b> 4*10 8P</p> 	<p>NH94005 <b>Flat Head Screws</b> 4*26 4P</p> 
<p>NH94006 <b>Flat Head Screws</b> 4*42 4P</p> 	<p>NH94007 <b>Button Head Self Tapping Screws</b> 4*14 6P</p> 	<p>NH94008 <b>Button Head Self Tapping Screws</b> 3*12 4P</p> 	<p>NH94009 <b>Ring Head Self Tapping Screws</b> 3*8 4P</p> 
<p>NH94010 <b>Button Head Self Tapping Screws</b> 3*8 4P</p> 	<p>NH94011 <b>Button Head Screws</b> 3*14 8P</p> 	<p>NH94012 <b>Button Head Screws</b> 3*18 8P</p> 	<p>NH94013 <b>Ball Head Self Tapping Screws</b> 2*6 4P</p> 

<p>NH94014  <b>Button Head Hex.  Mechanical Screw</b>  3*24     4P</p> 	<p>NH94015  <b>Shock Insert Upper  Cups</b>     4P</p> 	<p>NH94016  <b>Front /rear  Lower Inside Hinge Pin Set</b>  68mm     4P</p> 	<p>NH94025  <b>Battery Compartment</b></p> 
<p>NH94026  <b>Servo Horns</b></p> 	<p>NH94035  <b>Servo Unit</b></p> 	<p>NH94027  <b>Set Screws M3*4</b>  12P</p> 	<p>NH94028  <b>Set Screws M4*4</b>  8P</p> 
<p>NH94029  <b>Bearings 10*5*4</b>  4P  <b>(For Clutch Bell)</b></p> 			

<p><b>Radio Plate  (Carbon Fibre)</b></p> 	<p><b>Rear Shock Plate (Al.)</b></p> 	<p><b>Front Shock Plate (Al.)</b></p> 	<p><b>Center Diff. Mounts 2P (Al.)</b></p> 
---	--	--	--

<p>NH93985 <b>Fuel Tank(125cc)</b></p>	<p>NH94036 <b>Chassis</b></p>	<p>NH93897 <b>Clutch Bell</b></p>	<p>NH93914 <b>Wheels Complete</b> 2P</p>
<p>NH93901 <b>Front Lower Suspension Arm</b> 2P</p>	<p>NH93934 <b>Steering Links</b> 2P</p>	<p>NH93905 <b>Tail Wing</b></p>	<p>NH93906 <b>Side Guard(L/R)</b></p>
<p>NH93908 <b>Front Bumper</b></p>	<p>NH93909 <b>Rear Lower Suspension Arm</b> 2P</p>	<p>NH93910 <b>Front Upper Suspension Arm</b> 2P</p>	<p>NH93911 <b>Rear Upper Link</b></p>
<p>NH93926 <b>Wing Stay Posts</b></p>	<p>NH93917 <b>Front Sway Bar +Links</b></p>	<p>NH93918 <b>Rear Sway Bar +Links</b></p>	<p>NH93925 <b>Wing Stay</b> 2P</p>
<p>NH93875 <b>Center Diff Top Plate</b></p>	<p>NH93878 <b>Rear Dogbones</b> 2P</p>	<p>NH93879 <b>Center Dogbones (Front+Rear)</b> 2P</p>	<p>NH93880 <b>Rear Shock Tower</b></p>
<p>NH93881 <b>Front Shock Tower</b></p>	<p>NH93883 <b>Radio Tray</b></p>	<p>NH93886 <b>Front Universal Dogbones</b> 2P</p>	<p>NH93890 <b>Main Gear (46T)</b></p>