

NINCO 4RC[®]

4WD RC ELECTRIC CARS

1/14 SPORT RALLY RTR 2,4Ghz



MANUAL DEL USUARIO
USER HANDBOOK
MANUAL DO USUARIO

HANDBUCH
MANUEL DE L'UTILISATEUR
HANDBOEK

www.ninco.com

SINCRONIZACIÓN (COCHE-EMISORA) / BINDING PROCESS (CAR - TRANSMITTER)

- 1- Mantener pulsado el botón BIND (A) al mismo tiempo que ponemos en marcha la emisora: ON (B)

Press and hold "BIND" button (A) while we turn on the transmitter (B).

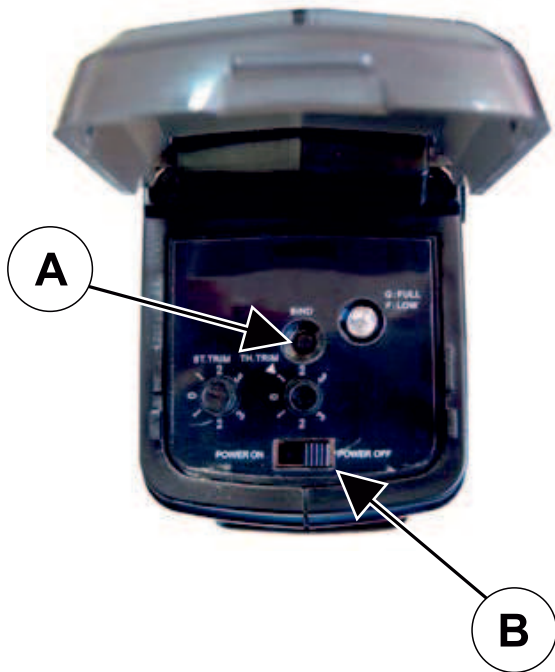

- 2- Mantener pulsado el botón BIND (C) al mismo tiempo que ponemos en marcha el coche: ON (D)

Press and hold "BIND" button (C) while we turn on the car (D).

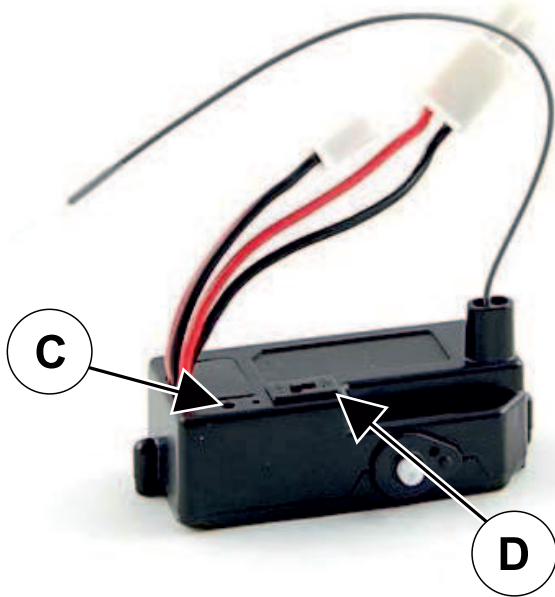

- 3- Espere... / Wait...



5"

- 4- Apagar coche y emisora. / Turn off car and transmitter.

- 5- Encender emisora y coche...¡ya están sincronizados! / Turn on transmitter and car...binding process is already done!

Por favor, lea atentamente las instrucciones antes de manipular este vehículo.

ESPECIFICACIONES:

NH93031/32 – 1/14 SPORT RALLY 2,4 Ghz

Longitud	Anchura	Altura	Dist. entre ejes	Relación	Altura chasis	Diámetro rueda	Anchura rueda (d/t)	Motor
282mm	165mm	125mm	155mm	1:8,8	16mm	58mm	28mm	Rc370

CONTENIDO:

Artículos necesarios para el funcionamiento del vehículo, incluidos en el set:



- Coche
- Emisora 2,4Ghz
- Motor
- PBC 3-1 (Servo-ESC-RX)
- Bateria Ni-MH 7,2v 1100mAh
- Requiere 8 pilas AA

NOTA:

- Cargar la batería durante 8 o 10 horas antes de su primer uso. No dejarla desatendida durante el proceso de carga.
- Cuando el coche está bloqueado, no continuar activando el gatillo. Puede sobrecalentar y dañar el variador.

Los siguientes artículos, no incluidos en el set, son necesarios para la manipulación y montaje del vehículo:

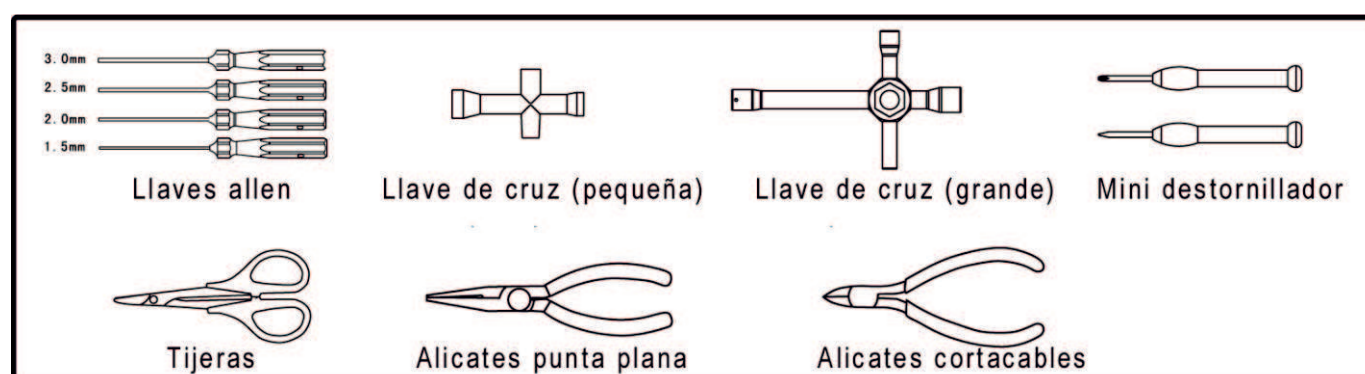

LA EMISORA

La emisora requiere 8 pilas AA para su funcionamiento.

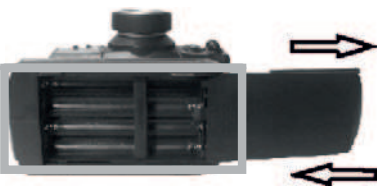

Retira la tapa para acceder al compartimiento de las pilas.

Vuelve a poner la tapa una vez las pilas ya colocadas.

Precaución con las pilas:

Se recomienda el uso de pilas alcalinas de 1,5v en lugar de recargables de 1,2v.

Vigile la correcta colocación de la polaridad

No usar baterías de diferentes tipos ni mezclar nuevas y usadas.

Retirar las pilas si no va a usar la emisora en un largo periodo de tiempo.

Sustituya las pilas según marque el indicador de nivel.

Funciones de la emisora:



- 4. Trim dirección
- 5. Trim acelerador
- 6. Gatillo acelerador
- 7. Botón asociación
- 8. Indicadores potencia
- 9. Interruptor encendido
- 10. Led encendido
- 11. Control dirección

Cómo conducir:



1. Gatillo en posición neutra
(coche parado)



2. Apretar gatillo
(marcha adelante)



3. Volver a neutro
(desaceleración)



4. Abrir gatillo
(freno en seco)



5. Dejar de nuevo
en neutro (activa el variador)



6. Abrir gatillo
(marcha atrás)

Please read carefully the instructions before using the car.

FEATURES:

NH93031/32 – 1/14 SPORT RALLY 2,4 Ghz

Length	Width	Height	Wheel base	Gear ratio	Ground clearance	Wheel diameter	Wheel width	Motor
282mm	165mm	125mm	155mm	1:8,8	16mm	58mm	28mm	Rc370

CONTENTS:

Items needed for running



- Car
- Transmitter 2,4Ghz
- Motor
- PBC 3-1 (Servo-ESC-RX)
- Battery Ni-MH 7,2v 1100mAh
- 8 AA batteries required

Transmitter 2,4Ghz

NOTE:

-Charge the battery for 8-10 hours for the first time usage. Do not charge the battery unattended.

-When the car is blocked, do not continue to pull/push the trigger, this will cause the ESC to overheat and damage the ESC

The following items, not included in the kit, are required for assembling your model:

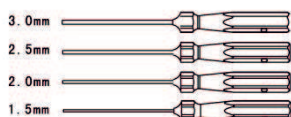

Hexagonal screwdriver

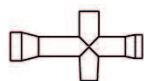

4-way cross wrench

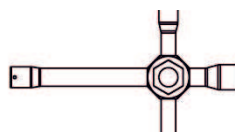

4-way cross wrench

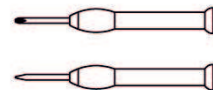

mini screwdriver



Scissors

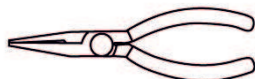

needle nose cutter

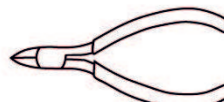

Wire cutter

TRANSMITTER

The transmitter requires 8 AA batteries.

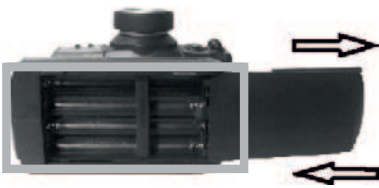

Slide the battery cover to open the battery compartment.

Replace the battery cover after 8AA batt. are installed.

Battery precautions:

We recommend to use the 1,5V alkaline batteries instead of the 1.2V chargeable batteries.

Do not install with wrong polarities.

Do not use batteries of different types and do not mix old and new batteries.

Do not leave batteries if not in use for a long period.

Please replace batteries when power indicators are weak

Function switches of the transmitter:

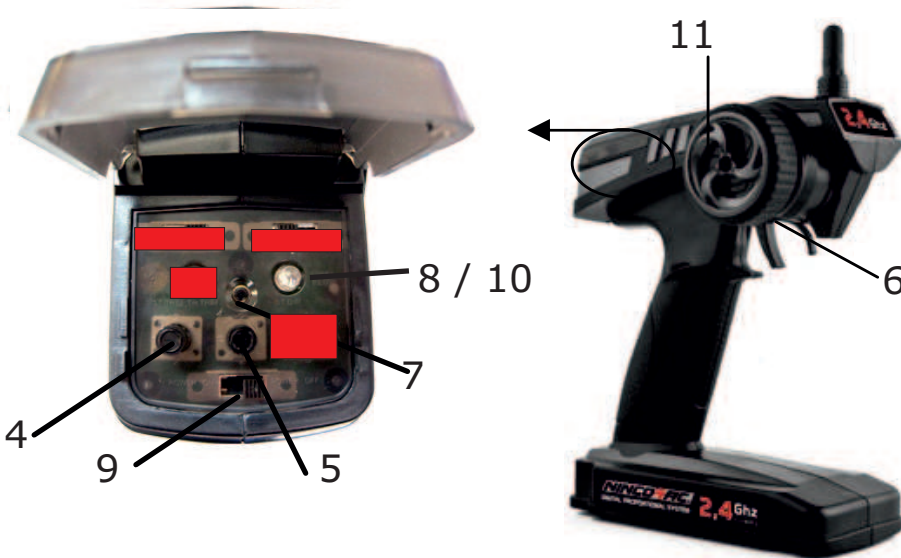

- 4. Steering trim
- 5. Throttle trim
- 6. Trigger
- 7. Binding
- 8. Power indicator
- 9. Switch on-off
- 10. On-off indicator
- 11. Control wheel

How to drive:



1. Trigger at the neutral position
(stop)



2. Pull the trigger
(decelerate)



3. Back to neutral



4. Push the trigger
(breaking)



5. Release the trigger
to neutral



6. Push the trigger
(backwards)

Por favor, lea atentamente as instruções antes de manipular este vehículo.

ESPECIFICACÕES:

NH93031/32 – 1/14 SPORT RALLY 2,4 Ghz

Cumprimento	Largura	Altura	Dist. entre eixos	Relação	Altura chasis	Diámetro roda	Altura roda	Motor
282mm	165mm	125mm	155mm	1:8,8	16mm	58mm	28mm	Rc370

CONTEUDO:

Artigos necesarios para o funcionamento del vehículo, incluidos no set:



- Coche
- Emisora 2,4Ghz
- Motor
- PBC 3-1 (Servo-ESC-RX)
- Bateria Ni-MH 7,2v 1100mAh
- Requiere 8 pilas AA

NOTA

- Carregar a bateria durante 8 a 10 horas antes de seu primeiro uso. Durante o proceso de carga, supervise a batería.
- Quando o carro está bloqueado, não continuar activando o gatillo. Pode sobreaquecer e danificar o variador.

Os seguintes artigos, não incluidos no set, são necessários para a manipulação e montagem do vehículo:

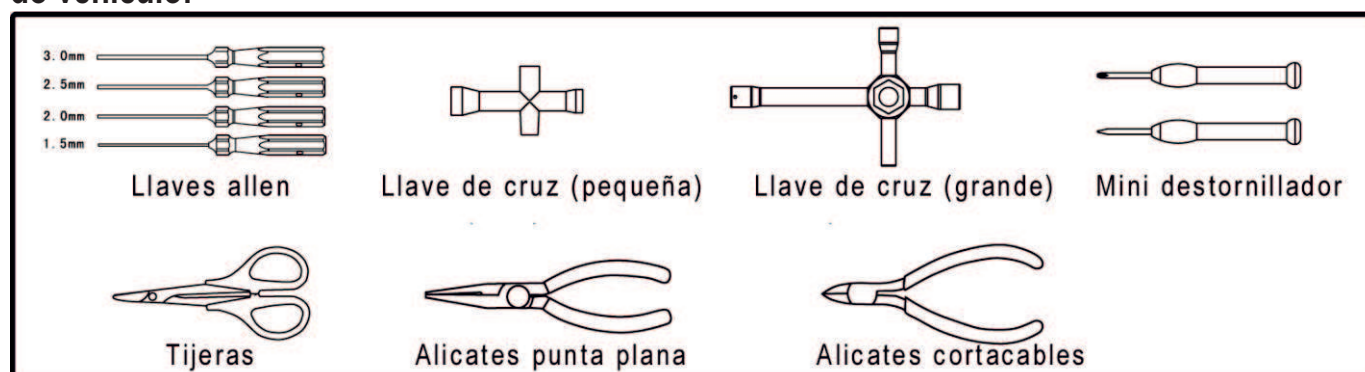

O EMISOR

O emisor requer 8 pilhas AA para o seu funcionamento.

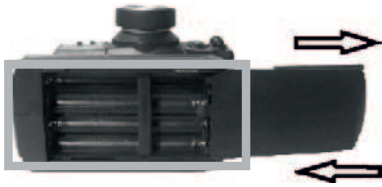

Retira a tampa para aceder ao compartimento das pilhas.

Volta a por a tampa uma vez as pilhas já colocadas.

Precaução com as pilhas:

Recomenda-se o uso de pilhas alcalinas de 1,5v em lugar de recarregáveis de 1,2v. Verifique a correcta colocação da polaridade.

Não usar baterias de diferentes tipos nem misturar novas e usadas.

Retirar as pilhas se não vai usar o emisor por um longo periodo de tempo.

Substitua as pilhas quando o nivel indicar.

Funções do emisor

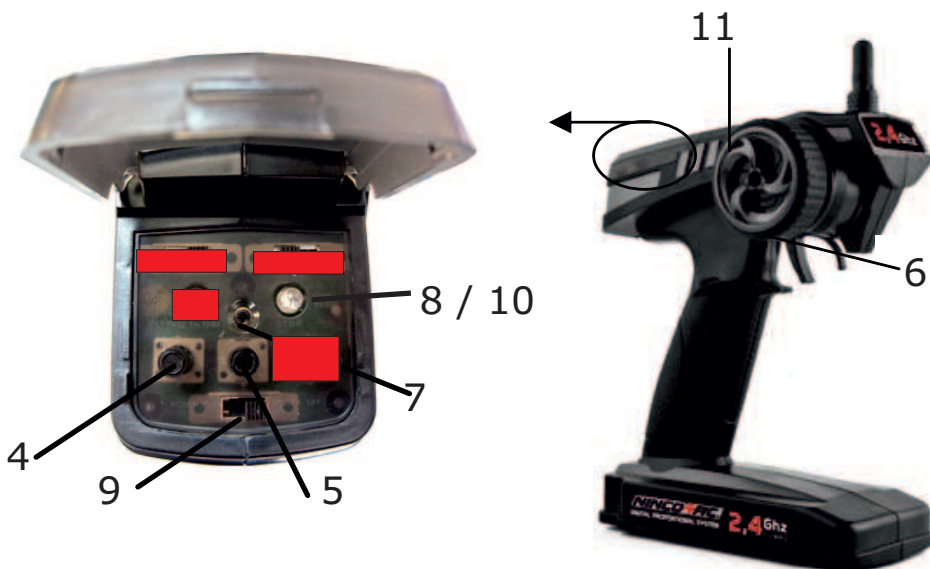

- 4. Direcção trim
- 5. Acelerador trim
- 6. Gatilho
- 7. Biding
- 8. Indicadores potencia
- 9. Interruptor para ligar
- 10. Indicador On-off
- 11. Control direcção

Como conduzir:



1. Gatilho em posição neutra
(carro parado)



2. Apertar gatilho
(marcha f rente)



3. Voltar a neutro
(desaceleração)



4. Empurrar gatilho
(trava em seco)



5. Deixar de novo em
neutro (activa o variador)



6. Empurrar gatilho
(marcha atrás)

Bitte lesen Sie aufmerksam diese Anleitung bevor Sie das Modell benutzen

EIGENSCHAFTEN:

NH93031/32 – 1/14 SPORT RALLY 2,4 Ghz

Länge	Breite	Höhe	Radstand	Ratio	Bodenfreiheit	Raddurchmesser	Reifenbreite	Motor
282mm	165mm	125mm	155mm	1:8,8	16mm	58mm	28mm	Rc370

INHALT:

Ausstattung des Modells Benötigte Teile um das Modell zu benutzen (enthalten):



- Farzeugh
- Sender 2,4Ghz
- Motor
- PBC 3-1 (Servo-ESC-RX)
- Batterie Ni-MH 7,2v 1100mAh
- 8 pilas AA (nitch enthalten)

ACHTUNG:

- Laden Sie den Akku das erste mal 8-10 Stunden auf bevor Sie ihn benutzen. Lassen Sie ihn dabei nicht unbeaufsichtigt
- Wenn etwas das Modell blockiert, geben Sie kein Gas mehr, dieses kann den Fahrregler überhitzen und zerstören

Die folgenden Teile (nicht enthalten) werden benötigt:

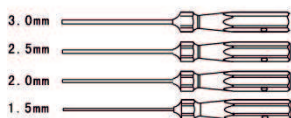

Inbus Schraubendreher



4-Wege Schraubenschlüssel

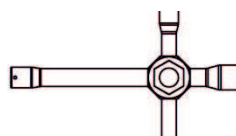

4-Wege Schraubenschlüssel

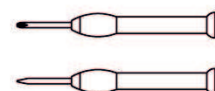

Mini Schraubendreher



Schere



Cutter Messer

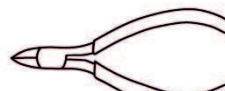

Seitenschneider

SENDER:

Der Sender benötigt 8 AA Batterien.



Schieben Sie den Batteriedeckel auf um an die Halterungen zu gelangen.

Schließen Sie den Batteriedeckel nachdem Sie die Batterien eingelegt haben.

Vorsichtsmaßnahmen:

Wir empfehlen die Verwendung von 1,5V Alka line Batterien anstelle von 1,2V Akkus.

Achten Sie auf die richtige Polarität

Verwenden Sie keine unterschiedlichen Batterien gleichzeitig

Nehmen Sie die Batterien aus dem Sender wenn Sie ihn länger nicht benutzen

Tauschen Sie die Batterien aus wenn diese nicht mehr die volle Leistung haben.

Funktionen des Senders:

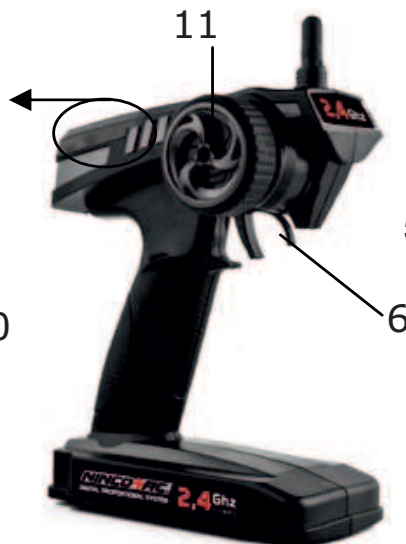
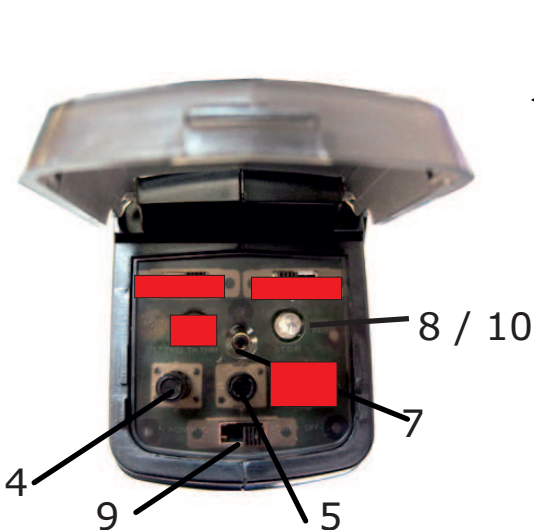

- für Steuerung
- 4. Steuerungs Feineinstellung
- 5. Gas/Bremse Feineinstellung
- 6. Abzug
- 7. Binding
- 8. Betriebs LED
- 9. An/Aus Schalter
- 10. Status LED
- 11. Steuerungsrad

Fahranleitung:



1. Abzug in Neutralstellung
(S top) (Vorwärts)



2. Ziehen des Abzugs
(Gas wegnehmen)



3. Zurück zu Neutral



4. Drücken des Abzugs
(Bremsen)



5. Loslassen des Abzugs
(Neutral Position)



6. Drücken des Abzugs
(Rückwärts)

Veuillez lire attentivement les instructions avant d'utiliser la voiture.

SPECIFICATIONS:

NH93031/32 – 1/14 SPORT RALLY 2,4 Ghz

Longueur	Largeur	Hauteur châssis	Entrave	Rapport d'engrenage	Garde au sol	Diamètre de roue	Largeur de roue	Moteur
282mm	165mm	125mm	155mm	1:8,8	16mm	58mm	28mm	Rc370

CONTENU:

Éléments nécessaires au fonctionnement de votre voiture (inclus):



Voiture
Emetteur 2,4Ghz
Motor
PBC 3-1 (Servo-ESC-RX)
Batterie Ni-MH 7,2v 1100mAh
8 piles AA (non inclusées)

NOTE:

- Rechargez la batterie pendant 8-10 heures lors de la première utilisation. Ne laissez pas la batterie sans surveillance pendant la charge.
- Lorsque la voiture est bloquée, n'appuyez pas sur la gâchette, car l'ESC risque de surchauffer et de s'endommager.

Les éléments suivants, non inclus dans le kit, sont nécessaires au montage de votre voiture.

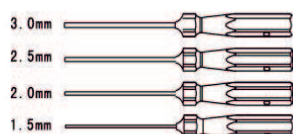

Tournevis hexagonal

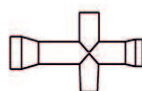

Clé en croix

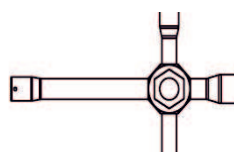

Clé en croix

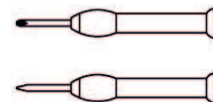

Tournevis miniature

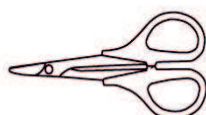

Ciseaux

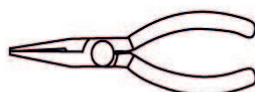

Pince à bec

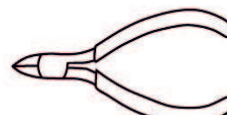

Coupe-câbles

ÉMETTEUR

L'émetteur nécessite 8 piles AA.

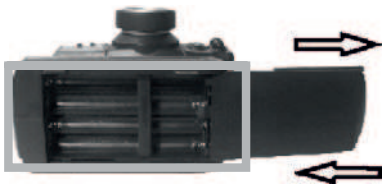

Faites glisser le couvercle des piles pour ouvrir le compartiment à piles.

Remettez le couvercle des piles après avoir installé les piles.

Précautions concernant les piles:

Nous vous recommandons d'utiliser des piles alcalines 1,5V plutôt que des piles rechargeables 1,2V.

Respectez les polarités.

Ne mélangez pas différents types de piles ou des piles neuves avec des piles usagées.

Enlevez les piles en cas de non-utilisation prolongée.

Remplacez les piles lorsque les indicateurs de puissance sont faibles.

Commandes des fonctions de l'émetteur:



- 4. Trim de direction
- 5. Trim d'accélération
- 6. Gâchette
- 7. Liason
- 8. Indicateur de puissance
- 9. Interrupteur on-off
- 10. Indicateur On-Off
- 11. Molette de contrôle

Comment conduire:



1. Gâchette au point mort (stop) 2. Tirez la gâchette
(marche avant) (décélérer)

3. Retour au point



4. Poussez la gâchette (freiner)
retour au point mort
arrière)

5. Relâchez la gâchette pour
gâchette (marche

6. Poussez la

Lees aandachtig de instructies voor het gebruik van de auto.

SPECIFICATIE:

NH93031/32 – 1/14 SPORT RALLY 2,4 Ghz

Lengte	Breedte	Hoogte	Wiel basis	Over-brenings-verhouding	Bodem-hoogte	Wiel diameter	Wiel breedte	Motor
282mm	165mm	125mm	155mm	1:8,8	16mm	58mm	28mm	Rc370

INHOUD

Items die nodig zijn zodat uw model rijdt (inbegrepen):



- Car
- Zender 2,4Ghz
- Motor
- PBC 3-1 (Servo-ESC-RX)
- Batterij Ni-MH 7,2v 1100mAh
- 8 batterijen AA (niet inbegrepen)

OPMERKING:

-Laad de batterij voor 8-10 uur voor het eerste gebruik. Laad de batterij niet onbeheerd.

-Wanneer de auto is geblokkeerd, blijf dan niet aan de hendel trekken/duwen, dit zal ertoe leiden dat de ESC oververhit raakt en de ESC beschadigt.

De volgende items, niet inbegrepen in de kit, zijn nodig voor het monteren van uw model.

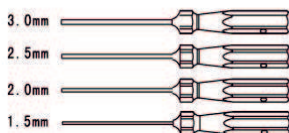

Hexagonale schroevendraaier

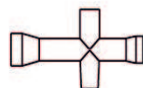

4-weg moersleutel

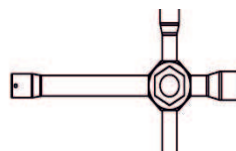

4-weg moersleutel

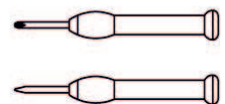

Mini schroevendraaier

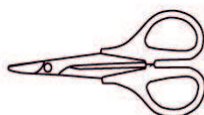

Scharen

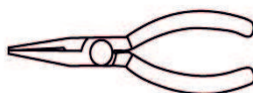

Puntige combinatietang

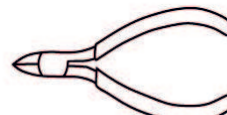

Draadtang

ZENDER

De zender heeft 8 AA batterijen nodig.

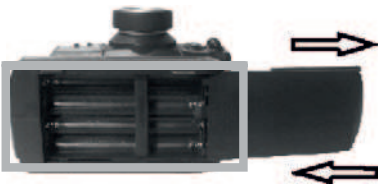

Schuif het batterijklepje op om de batterijbehuizing te openen.

Sluit het batterijklepje nadat de 8AA batterijen zijn geplaatst.

Batterij voorzorgsmaatregelen:

Wij raden het gebruik van 1,5V alkaline batterijen aan in plaats van de oplaadbare 1,2V batterijen.

Plaats niet met verkeerde polariteit.

Gebruik geen verschillende batterij-types en mix geen oude en nieuwe batterijen.

Laat geen batterijen achter indien ze niet gebruikt worden voor een langere periode.

Vervang de batterijen wanneer de stroomindicatoren zwak zijn.

Schakelaarfuncties van de zender:



- 4. Stuurtrim
- 5. Versnellingstrim
- 6. Hendel
- 7. Binding
- 8. Stroomindicator
- 9. Aan-uit schakelaar
- 10. Aan-uit indicator
- 11. Stuurwiel

Hoe te rijden:



1. Trigger op de neutrale positie
(stop) (vooruit) (vertragen)



2. Duw de trigger



3. Terug naar neutraal























4. Duw de trigger (remmen)
neutraal









5. Laat de trigger los naar 6. Duw de trigger (achteruit)



DESCRIPTION	REF.		DESCRIPCIÓN
CHASSIS	NH94408		CHASIS
RADIO TRAY	NH94409		SUB CHASIS SUPERIOR
FRONT LOWER SUSPENSION ARM	NH94410		TRAPECIO INFERIOR DEL
REAR LOWER SUSPENSION ARM	NH94411		TRAPECIO INFERIOR TRAS
FRONT SHOCK TOWER	NH94412		SOPORTE AMORTIGUADOR DEL
REAR SHOCK TOWER	NH94413		SOPORTE AMORTIGUADOR TRAS
STEERING HUBS	NH94414		MANGUETAS DELANTERAS
REAR HUB CARRIER	NH94415		MANGUETAS TRASERAS
FRONT HUB CARRIER	NH94416		PORTA MANGUETAS
STEERING ARM COMPLETE	NH94417		REENVIOS DIRECCION
COVER GEAR	NH94418		TAPA CORONA
FRONT/REAR GEAR BOX	NH94419		CAJA DIFERENCIAL
CENTER DOGBONE	NH94420		PALIER CENTRAL
BATTERY COVER	NH94421		TAPA BATERIA
BATTERY COVER POST	NH94422		SOPORTE TAPA BATERIA
MOTOR MOUNT	NH94423		SOPORTE MOTOR
SERVO HORN	NH94424		BRAZO SERVO
REAR UPPER LINK A 43,5	NH94425		TRAPECIOS TRAS. SUPERIORES
FRONT UPPER LINK 38	NH94426		TRAPECIOS DEL. SUPERIORES
STEERING LINK 35,5	NH94427		TIRANTES DIRECCION

SERVO LINK 25	NH94428		TIRANTE BRAZO DIRECCION
FRONT/REAR DOG BONE 46	NH94429		PALIERES DEL/TRAS
DIFF CUP	NH94430		VASO DIFERENCIAL
FRONT SCHOCK ABSORBER	NH94431		AMORTIGUADOR DELANTERO
MOTOR	NH94432		MOTOR
FRONT/REAR LOWER SUSPEN. PIN 2X38	NH94433		PASADORES TRAPECIOS SUP.
STEERING PIN 2X23	NH94434		PASADORES DIRECCION
WHEEL HEX PIN 1,5X7	NH94435		PASADOR HEXAGONO
WHEEL AXLE 2P	NH94436		VASO RUEDA 2P
WHEEL HEX	NH94437		HEXAGONO RUEDA (SPORT RALLY
WASHER 5X2,2X1	NH94438		ARANDELA 5X2,2X1
BALL HEAD A	NH94439		BOLA ROTULA A
BALL HEAD B	NH94440		BOLA ROTULA B
BALL BEARING 8X3,5	NH94441		RODAMIENTO 8X3,5
BALL BEARING 6X3	NH94442		RODAMIENTO 6X3
BALL BEARING 4X3	NH94443		RODAMIENTO 4X3
MOTOR GEAR 13T	NH94444		PIÑON MOTOR 13T
DIFF MAIN GEAR 45T	NH94445		CORONA DIFERENCIAL 45T
DIFF MAIN GEAR COMPLETE	NH94446		DIFERENCIAL COMPLETO
FRONT/REAR GEAR BOX	NH94447		CAJA DIFERENCIAL COMPLETA (SPORT RALLY

BATTERY 7,2V 1100 mAh	NH94448		BATERIA 7,2V 1100 mAh
RADIO PCB (FS)	NH94449		RADIO PCB (FS)
SERVO	NH94450		SERVO
FRONT/REAR BODY POST	NH94451		SOPORTES CARROCERIA
REAR BUMPER	NH94452		PARACHOQUES TRASERO
FRONT BUMPER	NH94453		PARACHOQUES DELANTERO
WHEEL COMPLETE	NH94454		RUEDA COMPLETA
OIL BEARING 12X8X3,5	NH94455		CASQUILLO 12X8X3,5
DRIVE GEAR	NH94456		PIÑONES DIFERENCIAL
ROUND HEAD MACHINE SCREW 2X18	NH94457		TORNILLO CAB/ REDONDA 2X18
ROUND HEAD MACHINE SCREW 2,5X8	NH94458		TORNILLO CAB/ REDONDA 2,5X8
ROUND HEAD SCREW 2X6 BH	NH94459		TORNILLO CAB/ REDONDA 2X6 BH
ROUND HEAD SCREW 2X16 BH	NH94460		TORNILLO CAB/ REDONDA 2X16 BH
COUNTERSUNK HEAD SCREW 3X6	NH94461		TORNILLO CAB/ CONICA 3X6
COUNTERSUNK HEAD SCREW 2X6	NH94462		TORNILLO CAB/ CONICA 2X6
COUNTERSUNK HEAD SCREW 2X8	NH94463		TORNILLO CAB/ CONICA 2X8
FLATTENED HEAD MACHINE SCREW 2,5X6	NH94464		TORNILLO CAB/ REDONDA 2,5X6
CHARGER	NH94465		CARGADOR
CLEAR BODY	NH94466		CARROCERÍA TRANSPARENTE
REAR SCHOCK ABSORBER	NH94467		AMORTIGUADOR TRASERO

1/14 SPORT RALLY 4WD 2,4GHZ RTR

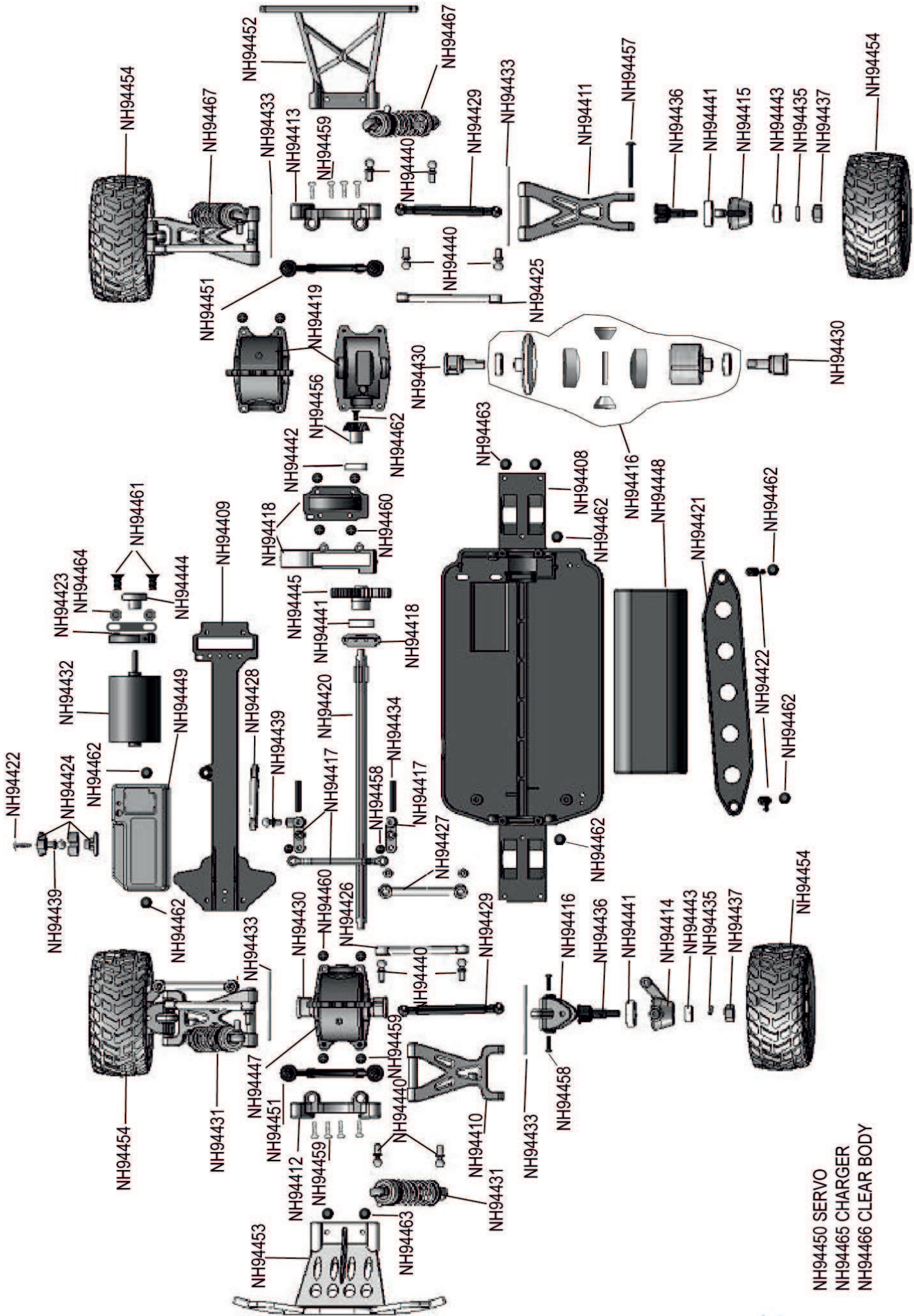

ESPAÑOL

Este es un producto complejo de hobby, no es un juguete. No recomendado para menores de 14 años. Debe ser usado con precaución y sentido común y requiere una un mínimo básico de habilidad para su pilotaje. No utilizar este producto de manera segura y responsable puede causar lesiones o daños en el propio producto u otras propiedades. Este producto no está recomendado para niños sin la estricta supervisión de un adulto. El manual del producto contiene instrucciones de seguridad, uso y mantenimiento. Es importante leer el manual y seguir las instrucciones y avisos que explica antes de manipularlo, prepararlo o usar para poder pilotarlo correctamente y evitar daños o lesiones.

ENGLISH

This is a sophisticated hobby product and not a toy. Children under the age of 14 are forbidden. It must be operated with caution and common sense and requires some basic mechanical ability. Failure to operate this product in a safe and responsible manner could result in injury or damage to the product or other property. This product is not intended for use by children without direct adult supervision. The product manual contains instructions for safety, operation and maintenance. It is essential to read and follow all the instructions and warnings in the manual, prior to assembly, setup or use, in order to operate correctly and avoid damage or injury.

PORTUGUES

Este é um produto completo de hobby, não é um brinquedo. Não recomendado para menores de 14 anos. Deve ser usado com precaução e sentido de responsabilidade, requer um mínimo básico de habilitação para sua pilotagem. Não utilizar este produto de maneira insegura ou irresponsável, pode causar lesões ou danos no próprio produto ou em outras propriedades. Este produto não é recomendado para crianças sem a supervisão de um adulto. O manual do produto contém instruções de segurança, uso e manutenção. É importante ler o manual e seguir as instruções e avisos que explica antes de o manipular, preparando-o para usar, poder pilota-lo correctamente e evitar danos ou lesões.

DEUTSCH

Dieses Modell ist ein hochentwickeltes Hobbygerät, kein Spielzeug. Es ist für Kinder unter 14 Jahre nicht geeignet. Es sollte mit viel Vorsicht und gesundem Menschenverstand verwendet werden und um ihn zu steuern ist ein Minimum an Handfertigkeit notwendig. Eine nicht sichere und unverantwortliche Verwendung kann zu Schäden am Modell selber als auch an anderen Gegenständen führen. Dieses Gerät ist nicht für Kinder ohne strikte Überwachung durch einen Erwachsenen geeignet. Aus dem Handbuch zu diesem Modell gehen wichtige Hinweise zur Sicherheit, Verwendung und Wartung hervor. Daher sollten Sie dieses aufmerksam lesen und die darin enthaltenen Anweisungen und Hinweise beachten, bevor Sie das Modell vorbereiten und in Betrieb nehmen. Auf diese Weise werden Sie lernen, ihn korrekt zu steuern und Schäden oder Verletzungen zu vermeiden.

FRANÇAIS

Ceci est un produit sophistiqué de loisirs et non un jouet. Interdit aux enfants de moins de 14 ans. Il doit être utilisé avec précaution et bon sens, nécessite des connaissances de base en mécanique. Le fait de ne pas utiliser ce produit d'une manière sécuritaire et responsable peut provoquer des blessures ou des dommages au produit ou à d'autres biens. N'est pas adapté à une utilisation par des enfants sans la surveillance directe d'un adulte. Le manuel contient des instructions relatives à la sécurité, à l'utilisation et à l'entretien de ce produit. Il est essentiel de lire et de suivre toutes ces instructions et les avertissements avant assemblage, installation ou utilisation du produit afin de garantir un fonctionnement correct, sans causer de dommages ou de blessures.

NEDERLANDS

Dit is een geavanceerd hobbyproduct en geen speelgoed. Het gebruik voor kinderen jonger dan 14 jaar is verboden. Het moet met voorzichtigheid en gezond verstand bediend worden en vereist wat mechanische basisvaardigheden. Het niet op een juiste manier veilig en verantwoordelijk omgaan met dit product kan resulteren in letsel of schade aan het product of andere eigendommen. Dit product is niet bedoeld voor gebruik door kinderen zonder direct toezicht van volwassenen. De producthandleiding bevat instructies voor veiligheid, bediening en onderhoud. Het is essentieel om alle instructies en waarschuwingen in de handleiding op te volgen, voorafgaand aan de montage, de installatie of het gebruik, om te zorgen voor een juiste werking en de voorkoming van schade of letsel.



SERVICIO TÉCNICO ON-LINE

Para garantía, recambios y atención al cliente visite www.ninco.com donde encontrará toda la información, videos, recambios y servicios disponibles.

ON-LINE CUSTOMER SERVICE

For service, spare parts and warranty visit www.ninco.com for all information, videos, spare parts and service available online.

NINCO DESARROLLOS S.L. hereby declares that this radio control system is in accordance with the basic requirements of the following European directives: 98/37 EG and 89/336/EWG and other relevant regulations of guideline 1999/5/EG (R&TTE). The original declaration of conformity can be obtained clicking **downloads** in the following internet address: www.ninco.com

NINCO DESARROLLOS S.L. declara que este sistema de radiocontrol está en conformidad con los requisitos básicos de la siguientes directivas europeas: 98/37 EG y los reglamentos pertinentes 89/336/CEE y de la directriz 1999/5/CE (R & TTE). La declaración de conformidad original se puede obtener haciendo clic en **descargas** en la siguiente dirección de Internet: www.ninco.com



NINCO4RC is brand of NINCO DESARROLLOS S.L.
Ctra. de l'Hospitalet 32
08940 Cornellà Barcelona Spain
CIF B-60307725 · www.ninco.com



C € 0678



MADE IN CHINA