

NH93008 - STONE CRAWLER 2,4 Ghz

Connect box with main gear assembly

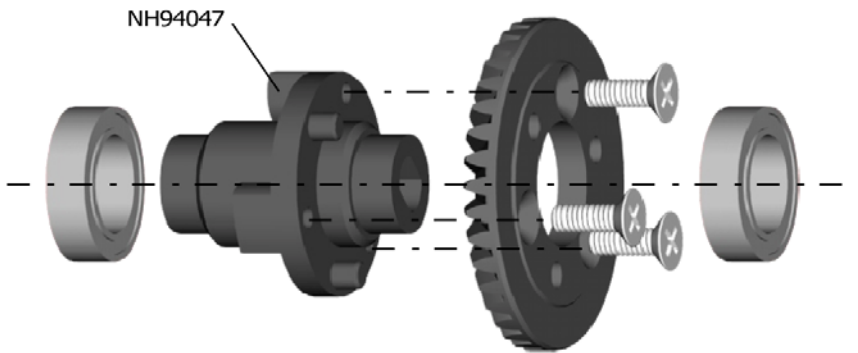

Servo arm assembly

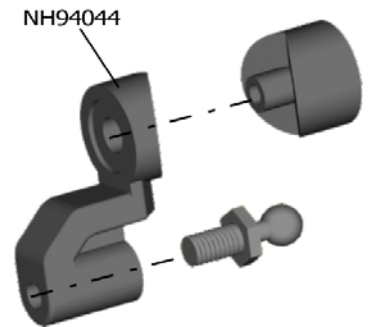

Servo mount assembly

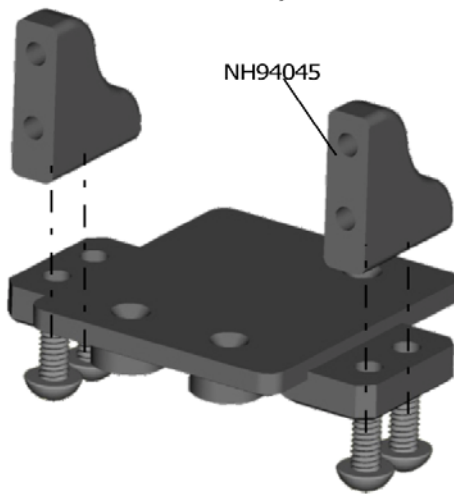

Adjustable linkage assembly



Servo link assembly

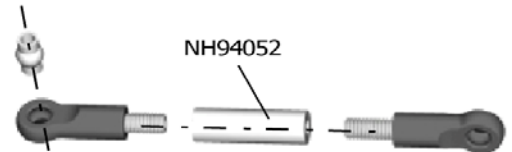

Side linkage

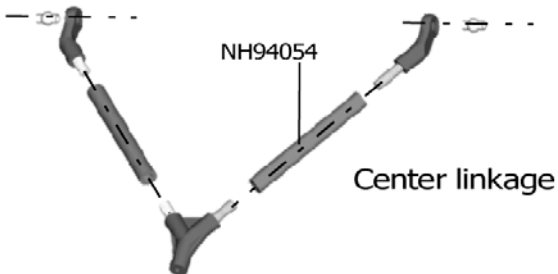

Center linkage

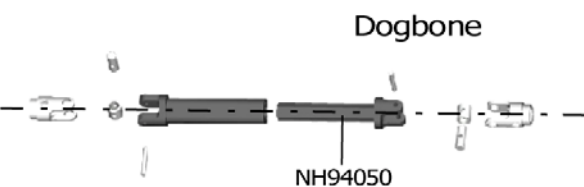

Dogbone

Shock absorber

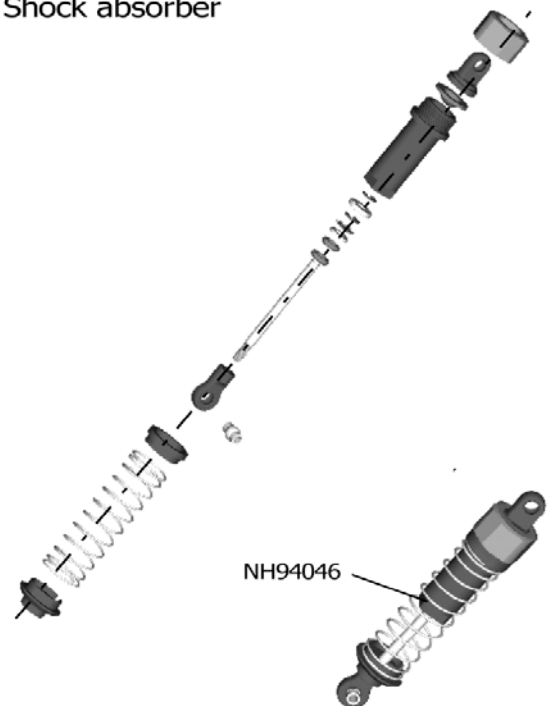

NH93008 - STONE CRAWLER 2,4 Ghz

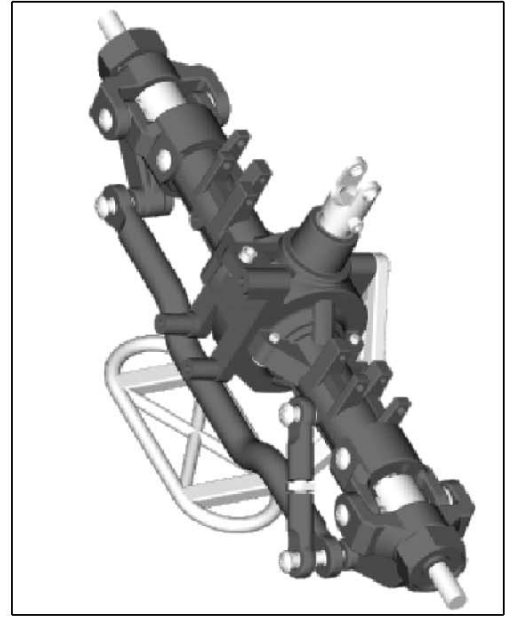
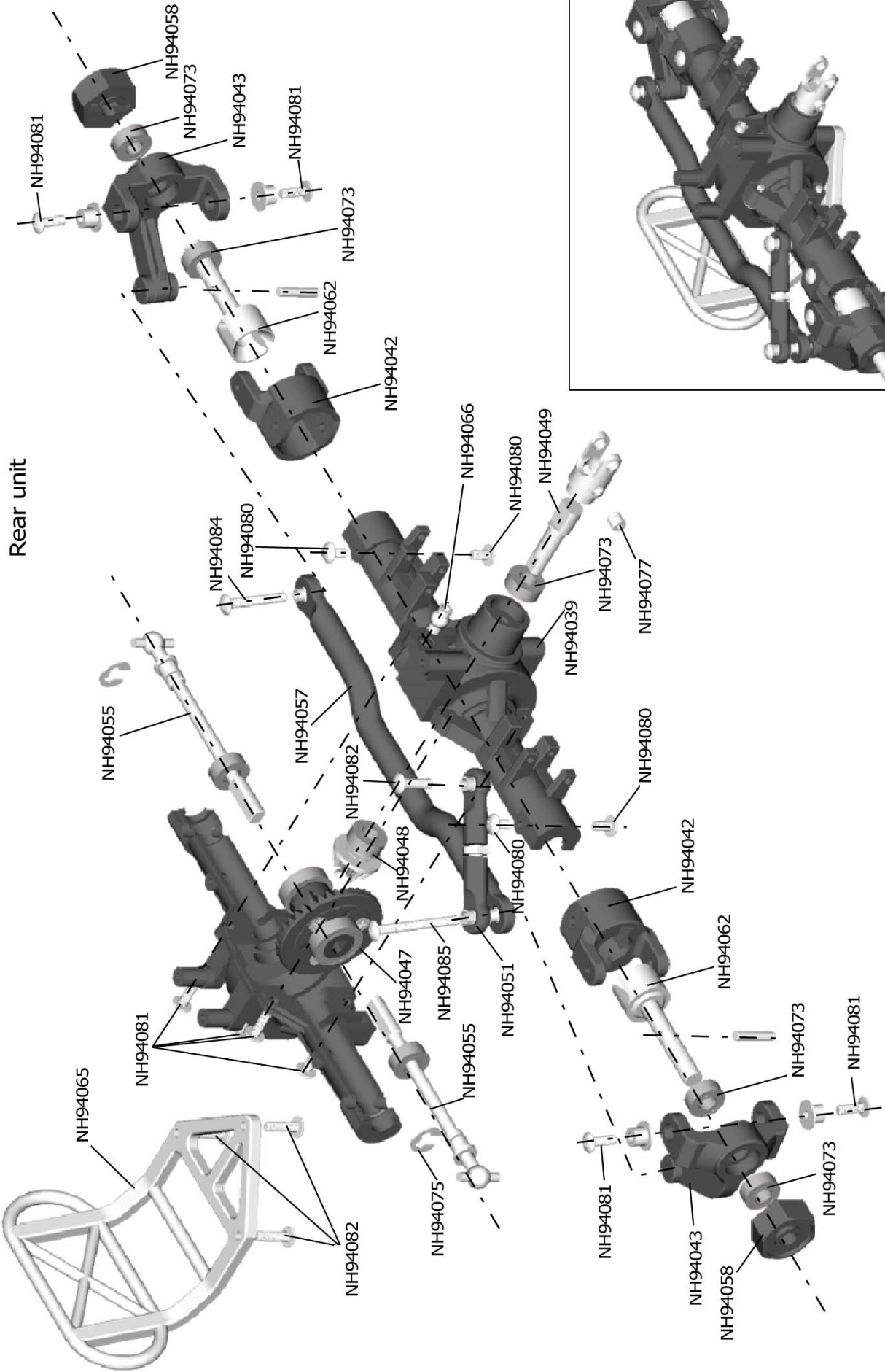

NH93008 - STONE CRAWLER 2,4 Ghz

Gear box

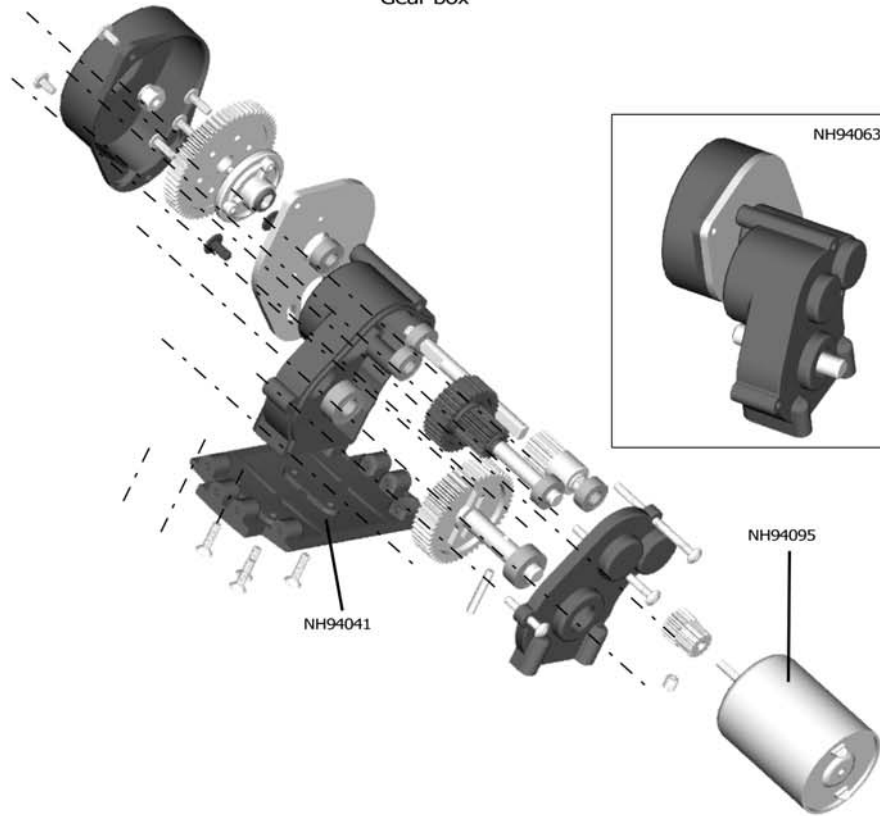

Wheel

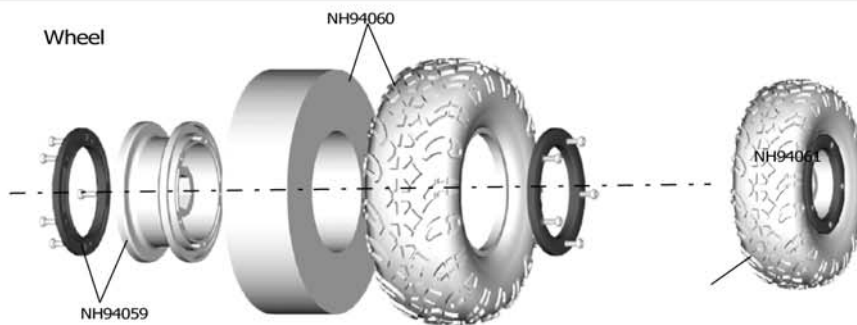



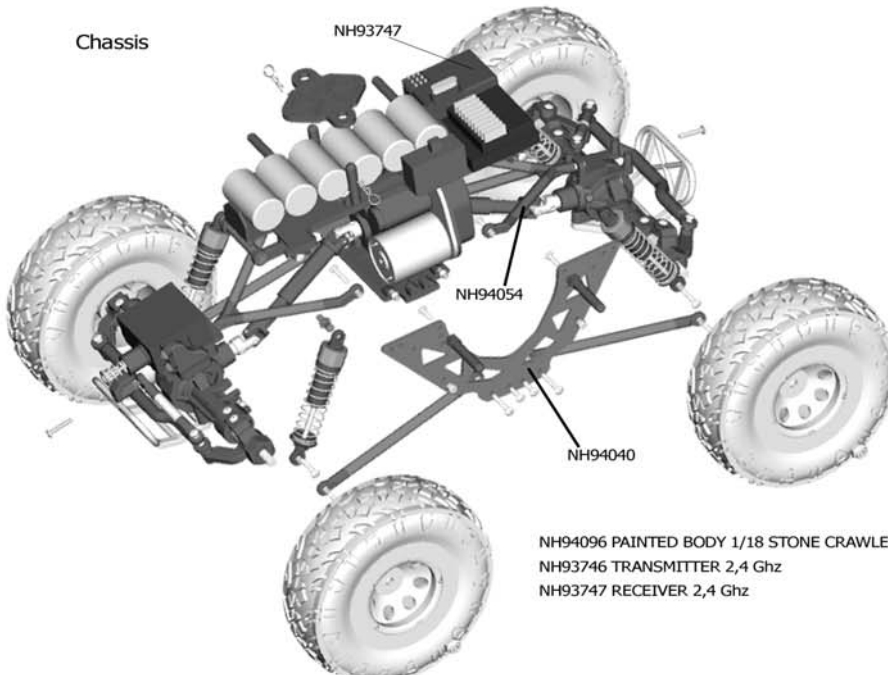









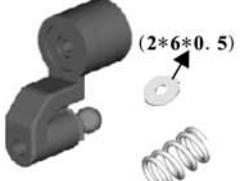







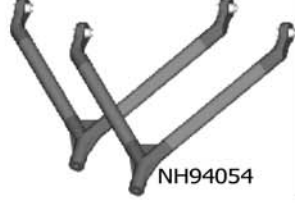





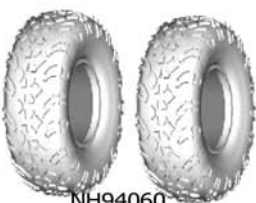
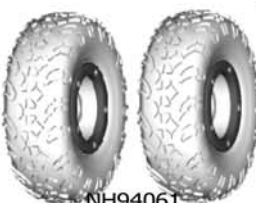



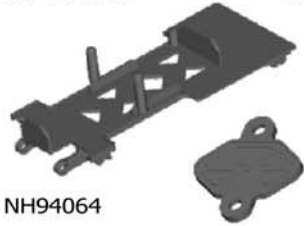









Chassis





NH94096 PAINTED BODY 1/18 STONE CRAWLER
NH93746 TRANSMITTER 2,4 Ghz
NH93747 RECEIVER 2,4 Ghz

1/10 XTREME CRAWLER SPARE PARTS

<p>F/R Gear Box</p>  <p>NH94039</p>	<p>Side Guard 2P</p>  <p>NH94040</p>	<p>Chassis</p>  <p>NH94041</p>	<p>Steering Mounts (L/R) 2P</p>  <p>NH94042</p>
<p>Steering Mounts (L/R) 2P</p>  <p>NH94043</p>	<p>Servo Arm</p>  <p>(2*6*0.5)</p> <p>NH94044</p>	<p>ServoPlate W/Servo Mount</p>  <p>NH94045</p>	<p>Shock Absorber 2P</p>  <p>NH94046</p>
<p>Connect Box w/main gear (38T)</p>  <p>NH94047</p>	<p>Drive Gear</p>  <p>NH94048</p>	<p>Drive shaft</p>  <p>NH94049</p>	<p>Universal Driven Dogbone 2P</p>  <p>NH94050</p>
<p>Adjustable Linkage</p>  <p>NH94051</p>	<p>Servo Linkage (41.27mm) 2P</p>  <p>NH94052</p>	<p>Side Linkage (86.9mm) 2P</p>  <p>NH94053</p>	<p>Center Linkage 2P</p>  <p>NH94054</p>
<p>Dogbone 4P</p>  <p>NH94055</p>	<p>Body Post 4P</p>  <p>NH94056</p>	<p>Connect Linkage 2P</p>  <p>NH94057</p>	<p>Wheel Hex. W/Pins (2*10) 4P</p>  <p>NH94058</p>
<p>Rim/Secure Ring 2P</p>  <p>NH94059</p>	<p>Tire w/Foam 2P</p>  <p>NH94060</p>	<p>Pre-Mounted Tire Set (L/R) 2P</p>  <p>NH94061</p>	<p>Wheel Axle 2P</p>  <p>NH94062</p>

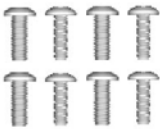
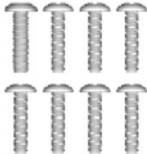
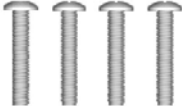
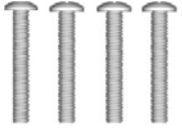
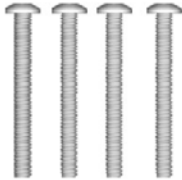
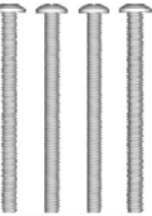
<p>Gear Box</p>  <p>NH94063</p>		<p>Battery Holder w/Covers 2P</p>  <p>NH94064</p>		<p>Bumper(F/R)</p>  <p>NH94065</p>	
<p>Servo(1.7kg)</p>  <p>NH94093</p>	<p>ESC</p>  <p>NH94094</p>	<p>Battery (NI-CH 7.2V 1100mAH)</p>  <p>NH93867</p>	<p>Motor(RC260) w/ Gear(14T)</p>  <p>NH94095</p>		
<p>Ball Stand $\phi 4.0$ 6P</p>  <p>NH94066</p>	<p>Ball Stand $\phi 4.0$ 6P</p>  <p>NH94067</p>	<p>NH94096 PAINTED BODY STONE CRAWLER</p>		<p>Nylon Nuts M4 8P</p>  <p>NH94068</p>	
<p>Nylon Nuts M3 8P</p>  <p>NH94069</p>	<p>Nylon Nuts M2 8P</p>  <p>NH94070</p>	<p>Ball Bearings (5*10*4) 8P</p>  <p>NH94071</p>	<p>Ball Bearings (7*11*3) 8P</p>  <p>NH94072</p>		
<p>Ball Bearings (4*8*3) 8P</p>  <p>NH94073</p>	<p>E-Clips 8P $\phi 2.0$</p>  <p>NH94074</p>	<p>E-Clips 4P $\phi 3.2$</p>  <p>NH94075</p>	<p>Washer 2*6*0.5 6P</p>  <p>NH94076</p>		
<p>Grub screw M3*3 4P</p>  <p>NH94077</p>	<p>Grub screw M4*3 4P</p>  <p>NH94078</p>	<p>Set Screw M3*15 6P</p>  <p>NH94079</p>	<p>Round Head Screw M2*4 8P</p>  <p>NH94080</p>		

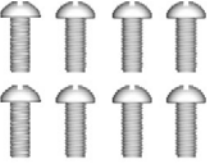
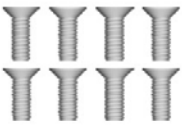
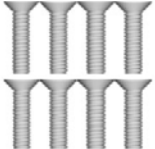
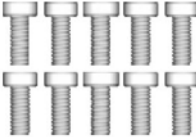
<p>Round Head Screw M2*6 8P</p>  <p>NH94081</p>	<p>Round Head Screw M2*8 6P</p>  <p>NH94082</p>	<p>Round Head Screw M2*12 4P</p>  <p>NH94083</p>	<p>Round Head Screw M2*14 4P</p>  <p>NH94084</p>
<p>Round Head Screw M2*20 4P</p>  <p>NH94085</p>	<p>Round Head Screw M2*27 8P</p>  <p>NH94086</p>	<p>Round Head Screw M2. 5*5 6P</p>  <p>NH94087</p>	<p>Round Head Screw M3*8 8P</p>  <p>NH94088</p>
<p>Countersink screw M2*6 8P</p>  <p>NH94089</p>	<p>Countersink screw M2*8 8P</p>  <p>NH94090</p>	<p>Column Head Screw M2*5 10P</p>  <p>NH94091</p>	

ESPAÑOL

Este es un producto complejo de hobby, no es un juguete. No recomendado para menores de 14 años. Debe ser usado con precaución y sentido común y requiere una un mínimo básico de habilidad para su pilotaje. No utilizar este producto de manera segura y responsable puede causar lesiones o daños en el propio producto u otras propiedades. Este producto no está recomendado para niños sin la estricta supervisión de un adulto. El manual del producto contiene instrucciones de seguridad, uso y mantenimiento. Es importante leer el manual y seguir las instrucciones y avisos que explica antes de manipularlo, prepararlo o usar para poder pilotarlo correctamente y evitar daños o lesiones.

ENGLISH

This is a sophisticated hobby product and not a toy. Children under the age of 14 are forbidden. It must be operated with caution and common sense and requires some basic mechanical ability. Failure to operate this product in a safe and responsible manner could result in injury or damage to the product or other property. This product in not intended for use by children without direct adult supervision. The product manual contains instructions for safety, operation and maintenance. It is essential to read and follow all the instructions and warnings in the manual, prior to assembly, setup or use, in order to operate correctly and avoid damage or injury.