



4WD RC ELECTRIC CARS



1/10 XTREM CRAWLER 2,4Ghz

1/18 BOWLDER CRAWLER 2,4Ghz



MANUAL DEL USUARIO  
USER HANDBOOK  
MANUAL DO USUARIO

HANDBUCH  
MANUEL DE L'UTILISATEUR  
HANDBOEK

[www.ninco4rc.com](http://www.ninco4rc.com)

Por favor, lea atentamente las instrucciones antes de manipular este vehículo.

**ESPECIFICACIONES:**

**NH93055 – 1/10 XTREM CRAWLER 2,4 Ghz**

Longitud	Anchura	Altura chasis	Dist. entre ejes	Relación	Peso	Diámetro/Anchura rueda	Ángulo dirección	Motor
430 mm	258mm	200mm	308mm	1:48	2kg	126/56mm	40-50°	RC540

**NH93052 – 1/18 BOULDER CRAWLER 2,4 Ghz**

Longitud	Anchura	Altura chasis	Dist. entre ejes	Relación	Peso	Diámetro/Anchura rueda	Ángulo dirección	Motor
314 mm	175mm	140mm	215mm	1:88	0,850kg	98/35mm	40-50°	RC260

**CONTENIDO:**

Artículos necesarios para el funcionamiento del vehículo, incluidos en el set:



Emisora 2,4Ghz



Motor



Variador



Servo



Batería 7,2v 1800mAh Ni-MH  
(1/18: Batería 7,2v 1100mAh Ni-MH)



Receptor 2,4Ghz



8 pilas AA  
(no incluidas)

**NOTA:**

-Cargar la batería durante 8 o 10 horas antes de su primer uso. No dejarla desatendida durante el proceso de carga.

-Cuando el coche está bloqueado, no continuar activando el gatillo. Puede sobrecalentar y dañar el variador.

Los siguientes artículos, no incluidos en el set, son necesarios para la manipulación y montaje del vehículo:

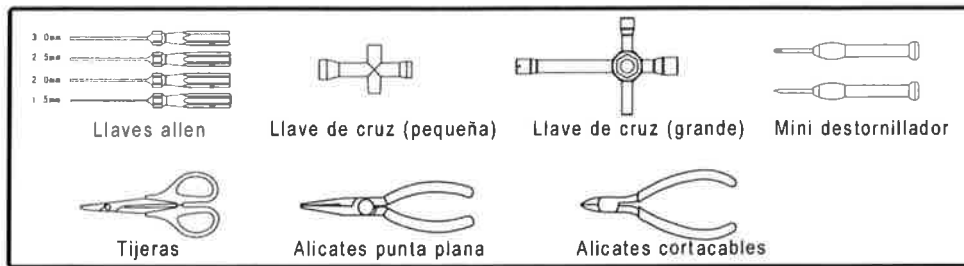

## LA EMISORA

La emisora requiere 8 pilas AA para su funcionamiento.



Retira la tapa para acceder al compartimiento de las pilas.

Vuelve a poner la tapa una vez las pilas ya colocadas.

### Precaución con las pilas:

Se recomienda el uso de pilas alcalinas de 1,5v en lugar de recargables de 1,2v.

Vigile la correcta colocación de la polaridad

No usar baterías de diferentes tipos ni mezclar nuevas y usadas.

Retirar las pilas si no va a usar la emisora en un largo periodo de tiempo.

Sustituya las pilas según marque el indicador de nivel.

### Funciones de la emisora:



1. Inversor acelerador
2. Inversor dirección
3. Dual rate dirección
4. Trim dirección
5. Trim acelerador
6. Gatillo acelerador
7. Botón asociación
8. Indicadores potencia
9. Interruptor encendido
10. Led encendido
11. Control dirección

### Cómo conducir:



1. Gatillo en posición neutra  
(coche parado)



2. Apretar gatillo  
(marcha adelante)



3. Volver a neutro  
(desaceleración)



4. Abrir gatillo  
(freno en seco)



5. Dejar de nuevo  
en neutro (activa el variador)



6. Abrir gatillo  
(marcha atrás)

### ASOCIACIÓN EMISORA-COCHE:

De serie, emisor y receptor están asociados. Basta encender la emisora, primero, y el coche, después, para que funcione. Si fuera necesario hacer la asociación proceda así:

- Colocar las pilas en la emisora sin ponerla en marcha.
- Colocar el conector puente suministrado en el receptor: canal BIND/CH3.
- Cambiar el conector que viene del variador y estaba en la posición CH2 al canal VCC.
- Conectar la batería del receptor.
- Ahora parpadeará la luz del receptor. Indica que el receptor está en modo de búsqueda de frecuencia.
- Presione el botón 'bind' de la emisora y, manteniéndolo pulsado, ponga en marcha la emisora. La luz verde parpadeará.
- La luz del receptor tiene que quedar fija en ese momento, indicando que está sincronizado.
- Desconectar la emisora y la batería del receptor.
- Retirar el conector puente del canal BIND/CH3 del receptor y volver a colocar el conector del variador en el canal CH2.
- Volver a poner en marcha la emisora. En ese momento, la luz verde dejará de parpadear, indicando que la sincronización se ha efectuado correctamente.
- De no haberse sincronizado correctamente, rogamos vuelva a realizar el proceso indicado.

Please read carefully the instructions before using the car.

**FEATURES:**

**NH93055 – 1/10 XTREM CRAWLER 2,4 Ghz**

Length	Width	Chassis height	Wheel base	Gear ratio	Weight	Diameter/ Width wheel	Steering angle	Motor
430 mm	258mm	200mm	308mm	1:48	2kg	126/ 56mm	40-50°	RC540

**NH93052 – 1/18 BOULDER CRAWLER 2,4 Ghz**

Length	Width	Chassis height	Wheel base	Gear ratio	Weight	Diameter/ Width wheel	Steering angle	Motor
314 mm	175mm	140mm	215mm	1:88	0,850kg	98/ 35mm	40-50°	RC260

**CONTENTS:**

Items needed for running your model (included):

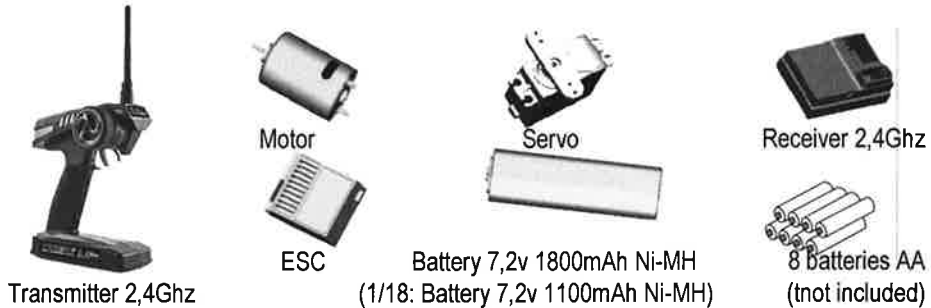

**NOTE:**

-Charge the battery for 8-10 hours for the first time usage. Do not charge the battery unattended.

-When the car is blocked, do not continue to pull/push the trigger, this will cause the ESC to overheat and damage the ESC

The following items, not included in the kit, are required for assembling your model:

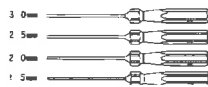

Hexagonal screwdriver

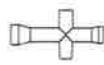

4-way cross wrench

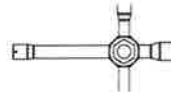

4-way cross wrench

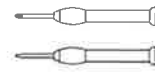

mini screwdriver



Scissors

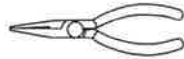

needle nose cutter

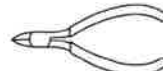

Wire cutter

## TRANSMITTER

The transmitter requires 8 AA batteries.



Slide the battery cover to open the battery compartment.

Replace the battery cover after 8AA batt. are installed.

### Battery precautions:

We recommend to use the 1,5V alkaline batteries instead of the 1.2V chargeable batteries.

Do not install with wrong polarities.

Do not use batteries of different types and do not mix old and new batteries.

Do not leave batteries if not in use for a long period.

Please replace batteries when power indicators are weak

### Function switches of the transmitter:

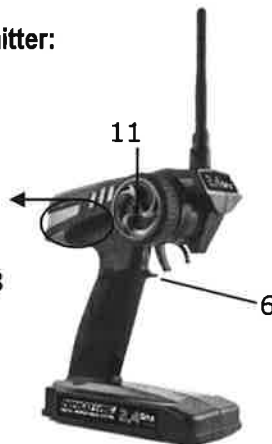

1. Throttle reverse switch
2. Steering reverse switch
3. Steering dual rate
4. Steering trim
5. Throttle trim
6. Trigger
7. Biding
8. Power indicator
9. Switch on-off
10. On-off indicator
11. Control wheel

### How to drive:



1. Trigger at the neutral position (stop)



2. Pull the trigger (forward)



3. Back to neutral (decelerate)



4. Push the trigger (braking)



5. Release the trigger to neutral



6. Push the trigger (backwards)

### **CAR-TRANSMITTER BINDING:**

As standard, transmitter and receiver are already bound or associated. Just turn on the transmitter first, followed by the car and it will work. If necessary, BINDING can be done by following these simple instructions.

- Put the batteries in the transmitter without turning it on.
- Put the match line provided on the channel BIND/CH3 of the receiver.
- Change the connector coming from the ESC and was in position CH2 to channel VCC.
- Connect the receiver battery.
- Now the light flashes on the receiver. That means that the receiver is going to the match status.
- Press and hold the 'bind' button on the transmitter and then switch on the power supply. The green light flashes.
- The light of the receiver has to be fixed at the time, indicating that it is synchronized.
- Disconnect the transmitter and the receiver battery.
- Remove the match line from the receiver BIND/CH3 channel and replace the ESC connector on the channel CH2.
- To launch the transmitter. At that time, the green light stops blinking, indicating that synchronization was successful.
- If no synchronized correctly, please redo the process indicated.

## PORTUGUES

Por favor, lea atentamente as instruções antes de manipular este veículo.

### ESPECIFICAÇÕES:

#### NH93055 – 1/10 XTREM CRAWLER 2,4 Ghz

Cumprimento	Largura	Altura chasis	Dist. entre eixos	Relação	Peso	Diâmetro/ Altura roda	Ângulo de direcção	Motor
430mm	258mm	200mm	308mm	1:48	2kg	126/56mm	40-50°	RC540

#### NH93052 – 1/18 BOULDER CRAWLER 2,4 Ghz

Cumprimento	Largura	Altura chasis	Dist. entre eixos	Relação	Peso	Diâmetro/ Altura roda	Ângulo de direcção	Motor
314 mm	175mm	140mm	215mm	1:88	0,850kg	98/35mm	40-50°	RC260

### CONTEUDO:

Artigos necesarios para o funcionamento del vehiculo, incluidos no set:

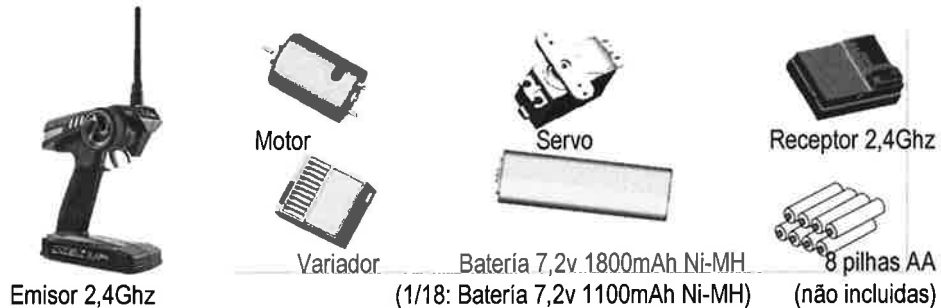

#### NOTA

-Carregar a bateria durante 8 a 10 horas antes de seu primeiro uso. Durante o proceso de carga, supervisione a bateria.

-Quando o carro está bloqueado, não continuar activando o gatillo. Pode sobreaquecer e danificar o variador.



Os seguintes artigos, não incluídos no set, são necessários para a manipulação e montagem do veículo:

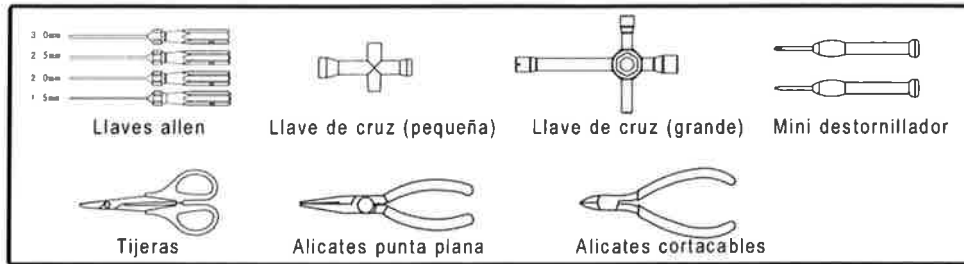

### O EMISOR

O emisor requer 8 pilhas AA para o seu funcionamento.



Retira a tampa para aceder ao compartimento das pilhas.

Volta a por a tampa uma vez as pilhas já colocadas.

### Precaução com as pilhas:

Recomenda-se o uso de pilhas alcalinas de 1,5v em lugar de recarregáveis de 1,2v.

Verifique a correcta colocação da polaridade.

Não usar baterias de diferentes tipos nem misturar novas e usadas.

Retirar as pilhas se não vai usar o emisor por um longo periodo de tempo.

Substitua as pilhas quando o nivel indicar.

### Funções do emisor



### Como conduzir:



1. Gatilho em posição neutra  
(carro parado)



2. Apertar gatilho  
(marcha frente)



3. Voltar a neutro  
(desaceleração)



4. Empurrar gatilho  
(trava em seco)



5. Deixar de novo em  
neutro (activa o variador)



6. Empurrar gatilho  
(marcha atrás)

### ASSOCIAÇÃO EMISSOR-CARRO

De série, o emissor e o receptor estão associados. Basta ligar o emissor primeiro e depois o carro para que funcione. No caso de ser necessário fazer a associação proceda da seguinte forma:

- Colocar as pilhas no emissor sem o ligar
- Colocar o conector ponte fornecido no receptor: canal BIND/CH3
- Mudar o conector que vem do variador e estava na posição CH2 ao canal VCC
- Ligar a bateria do receptor
- A luz do receptor pisca, indicando que está em modo de busca de frequência
- Carregue no botão "bind" do emissor e, mantendo-o carregado, ligue o emissor. A luz verde pisca.
- A luz do receptor tem que ficar fixa neste momento, indicando que está sincronizado.
- Desligar o emissor e a bateria do receptor
- Retirar o conector ponte do canal BIND/CH3 e voltar a colocar o conector do variador no canal CH2.
- Voltar a ligar o emissor. A luz verde deixará de piscar indicando que a sincronização se efectuou correctamente
- Se a sincronização não se efectuou correctamente, por favor volte a seguir o procedimento indicado.

Bitte lesen Sie aufmerksam diese Anleitung bevor Sie das Modell benutzen

**EIGENSCHAFTEN:**

**NH93055 – 1/10 XTREM CRAWLER 2,4 Ghz**

Länge	Breite	Höhe chassis	Radstand	Ratio	Gewicht	Raddurch/ Reifenbreite	Steuerung Winkel	Motor
430mm	258mm	200mm	308mm	1:48	2kg	126/ 56mm	40-50°	RC540

**NH93052 – 1/18 BOULDER XTREME CRAWLER 2,4 Ghz**

Länge	Breite	Höhe chassis	Radstand	Ratio	Gewicht	Raddurch/ Reifenbreite	Steuerung Winkel	Motor
314mm	175mm	140mm	215mm	1:88	0,850kg	98/ 35mm	40-50°	RC260

**INHALT:**

Ausstattung des Modells Benötigte Teile um das Modell zu benutzen (enthalten):

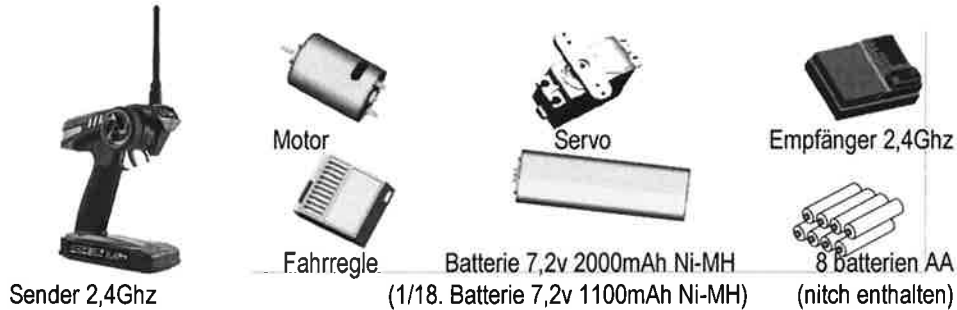

**ACHTUNG:**

- Laden Sie den Akku das erste mal 8-10 Stunden auf bevor Sie ihn benutzen. Lassen Sie ihn dabei nicht unbeaufsichtigt
- Wenn etwas das Modell blockiert, geben Sie kein Gas mehr, dieses kann den Fahrregler überhitzen und zerstören.

Die folgenden Teile (nicht enthalten) werden benötigt:

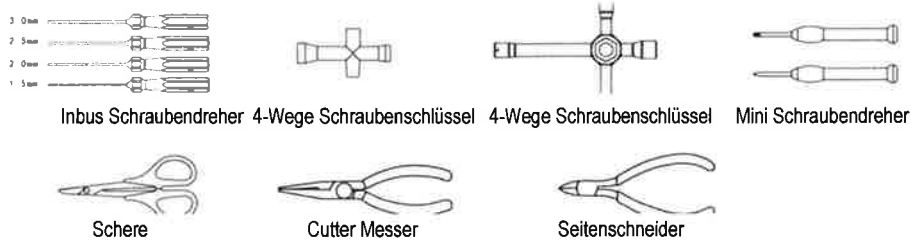

## SENDER

Der Sender benötigt 8 AA Batterien.



Schieben Sie den Batteriedeckel auf um an die Halterungen zu gelangen.

Schließen Sie den Batteriedeckel nachdem Sie die Batterien eingelegt haben.

### Vorsichtsmaßnahmen:

Wir empfehlen die Verwendung von 1,5V Alkaline Batterien anstelle von 1,2V Akkus.

Achten Sie auf die richtige Polarität

Verwenden Sie keine unterschiedlichen Batterien gleichzeitig

Nehmen Sie die Batterien aus dem Sender wenn Sie ihn länger nicht benutzen

Tauschen Sie die Batterien aus wenn diese nicht mehr die volle Leistung haben.

### Funktionen des Senders:

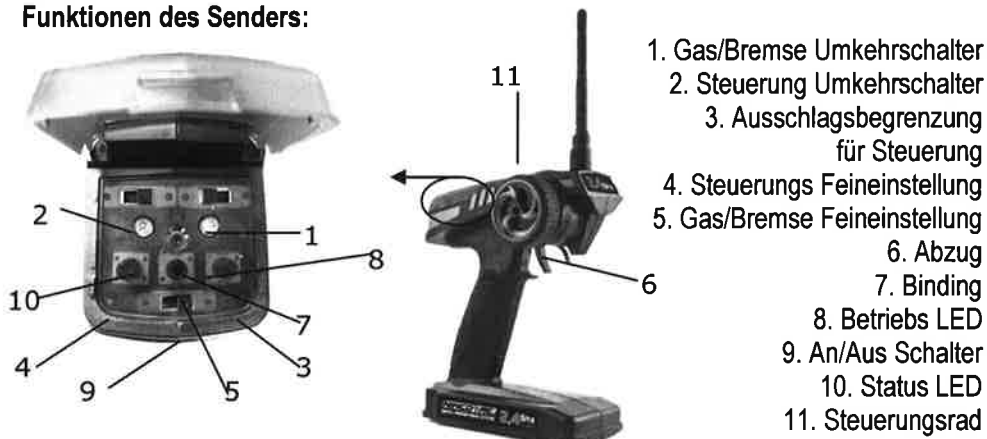

### Fahranleitung:



1. Abzug in Neutralstellung  
(Stop)



2. Ziehen des Abzugs  
(Vorwärts)



3. Zurück zu Neutral  
(Gas wegnehmen)



4. Drücken des Abzugs  
(Bremsen)



5. Loslassen des Abzugs  
(Neutral Position)



6. Drücken des Abzugs  
(Rückwärts)

### AUTO-SENDER BINDINGSENDER/EMPFÄNGER ABGLEICH

Im Auslieferungszustand ist der Sender bereits mit dem Empfänger verbunden. Falls nötig kann das binden der beiden Komponenten sehr einfach durchgeführt werden.

- Legen Sie die Batterien in den Sender ohne ihn einzuschalten.
- Stecken Sie das Programmierkabel auf den Kanal 3/BIND des Empfängers.
- Stecken Sie das Kabel des Reglers vom Steckplatz Kanal 2 in den Kanal VCC.
- Schließen Sie den Empfänger Akku an.
- Jetzt blinkt ein Licht am Empfänger. Das bedeutet der Empfänger ist im Programmier Modus.
- Drücken und halten Sie den BIND Taster auf dem Sender und schalten diesen ein. Ein grünes Licht am Sender blinkt.
- Wenn das Licht auf dem Empfänger dauerhaft leuchtet, ist die Synchronisation abgeschlossen.
- Trennen Sie Sender und Empfänger von der Stromversorgung.
- Entfernen Sie das Programmierkabel aus dem Kanal 3/BIND und stecken Sie das Kabel des Reglers wieder in Kanal 2.
- Benutzung des Senders. Ab diesem Moment hört das grüne Licht auf zu blinken. Das bedeutet die Synchronisation war erfolgreich.
- Sollte Sie Synchronisation nicht erfolgreich gewesen sein, wiederholen Sie die o.g. Schritte.

Veuillez lire attentivement les instructions avant d'utiliser la voiture.

### SPECIFICATIONS:

#### NH93055 – 1/10 XTREM CRAWLER 2,4 Ghz

Longueur	Largeur	Hauteur châssis	Entrave	Rapport d'engrenage	Poids	Diamètre / Largeur de roue	Angle de direction	Motor
430mm	258mm	200mm	308mm	1:48	2kg	126/56mm	40-50°	RC540

#### NH93052 – 1/18 BOULDER CRAWLER 2,4 Ghz

Longueur	Largeur	Hauteur châssis	Entrave	Rapport d'engrenage	Poids	Diamètre / Largeur de roue	Angle de direction	Motor
314mm	175mm	140mm	215mm	1:88	0,850kg	98/35mm	40-50°	RC260

### CONTENU:

Éléments nécessaires au fonctionnement de votre voiture (inclus):

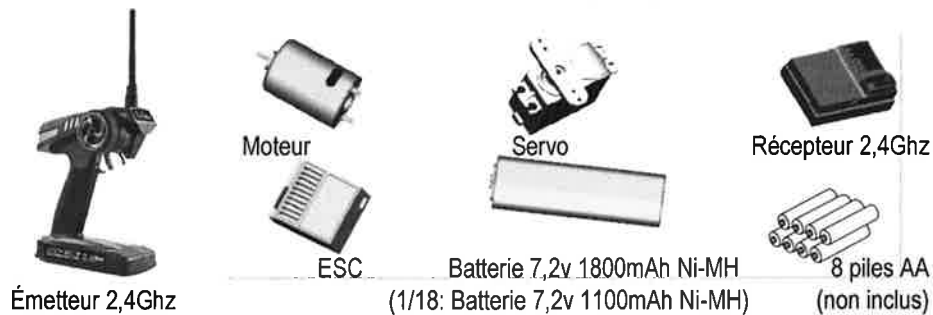

#### NOTE:

- Rechargez la batterie pendant 8-10 heures lors de la première utilisation. Ne laissez pas la batterie sans surveillance pendant la charge.
- Lorsque la voiture est bloquée, n'appuyez pas sur la gâchette, car l'ESC risque de surchauffer et de s'endommager.

Les éléments suivants, non inclus dans le kit, sont nécessaires au montage de votre voiture.

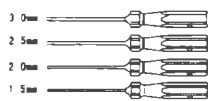

Tournevis hexagonal

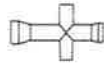

Clé en croix

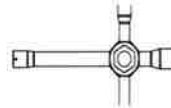

Clé en croix

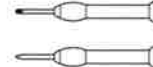

Tournevis miniature



Ciseaux

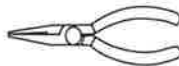

Pince à bec

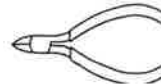

Coupe-câbles

## ÉMETTEUR

L'émetteur nécessite 8 piles AA.



Faites glisser le couvercle des piles pour ouvrir le compartiment à piles.

Remettez le couvercle des piles après avoir installé les piles.

### Précautions concernant les piles:

Nous vous recommandons d'utiliser des piles alcalines 1,5V plutôt que des piles rechargeables 1,2V.

Respectez les polarités.

Ne mélangez pas différents types de piles ou des piles neuves avec des piles usagées.

Enlevez les piles en cas de non-utilisation prolongée.

Remplacez les piles lorsque les indicateurs de puissance sont faibles.

### Commandes des fonctions de l'émetteur:

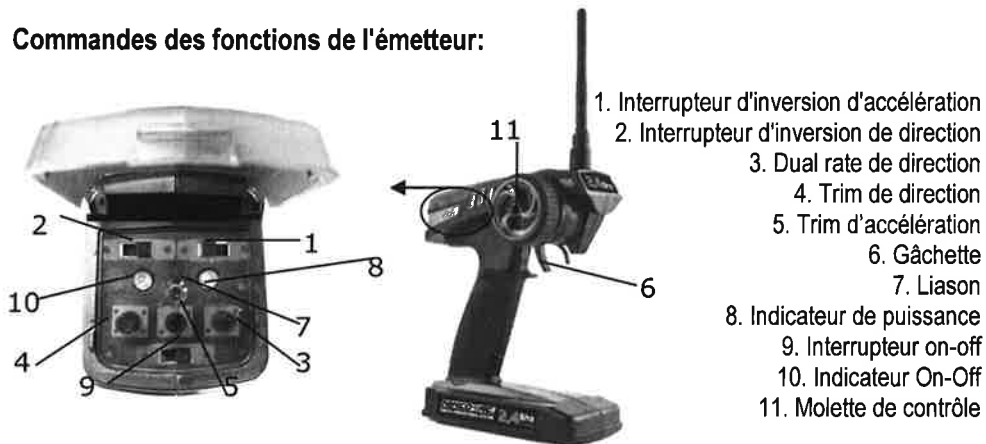

1. Interrupteur d'inversion d'accélération
2. Interrupteur d'inversion de direction
3. Dual rate de direction
4. Trim de direction
5. Trim d'accélération
6. Gâchette
7. Liason
8. Indicateur de puissance
9. Interrupteur on-off
10. Indicateur On-Off
11. Molette de contrôle

### Comment conduire:



1. Gâchette au point mort (stop)



2. Tirez la gâchette (marche avant)



3. Retour au point mort (décélérer)



4. Poussez la gâchette (freiner)



5. Relâchez la gâchette pour retour au point mort



6. Poussez la gâchette (marche arrière)

### LIAISON VOITURE/ÉMETTEUR:

A l'achat, l'émetteur et le récepteur sont déjà liés ou associés. Allumez l'émetteur en premier puis la voiture, et elle se commencera à fonctionner. Si nécessaire, la LIAISON peut être effectuée en suivant les simples instructions suivantes.

- Insérer les piles dans l'émetteur sans le mettre en marche.
- Placer le connecteur pont livré dans le récepteur : canal BIND/CH3.
- Changer le connecteur qui vient du variateur et qui était sur la position CH2 et le mettre sur le canal VCC.
- Connecter la batterie du récepteur.
- La lumière du récepteur se met alors à clignoter. Ceci indique le récepteur est en mode recherche de fréquence.
- Appuyez sur le bouton «bind» de l'émetteur, maintenez-le enfoncé, et mettez l'émetteur en marche. La lumière verte clignotera.
- La lumière du récepteur doit alors rester fixe, indiquant qu'il est synchronisé.
- Déconnecter l'émetteur et la batterie du récepteur.
- Retirer le connecteur pont du canal BIND/CH3 du récepteur et placer à nouveau le connecteur du variateur sur le canal CH2.
- Mettre l'émetteur en marche à nouveau. A ce moment-là, la lumière cessera de clignoter, indiquant que la synchronisation s'est effectuée correctement.
- Si la synchronisation n'a pas eu lieu de manière correcte, veuillez réaliser à nouveau le processus indiqué.



Lees aandachtig de instructies voor het gebruik van de auto.

**SPECIFICATIE:**

**NH93055 – 1/10 XTREM CRAWLER 2,4 Ghz**

Lengte	Beedte	Hoogte chassis	Wiel-basis	Over-brenings-verhouding	Gewicht	Wiel diameter / breedte	Hoek stuur	Motor
430mm	258mm	200mm	308mm	1:48	2kg	126/56mm	40-50°	RC540

**NH93052 – 1/18 BOULDER CRAWLER 2,4 Ghz**

Lengte	Beedte	Hoogte chassis	Wiel-basis	Over-brenings-verhouding	Gewicht	Wiel diameter / breedte	Hoek stuur	Motor
314mm	175mm	140mm	215mm	1:88	0,850kg	98/35mm	40-50°	RC260

**INHOUD**

Items die nodig zijn zodat uw model rijdt (inbegrepen):

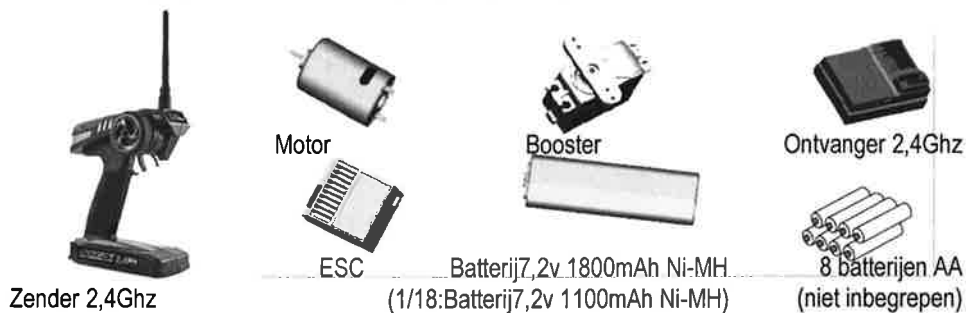

**OPMERKING:**

-Laad de batterij voor 8-10 uur voor het eerste gebruik. Laad de batterij niet onbeheerd.

-Wanneer de auto is geblokkeerd, blijf dan niet aan de hendel trekken/duwen, dit zal ertoe leiden dat de ESC oververhit raakt en de ESC beschadigt.

De volgende items, niet inbegrepen in de kit, zijn nodig voor het monteren van uw model.

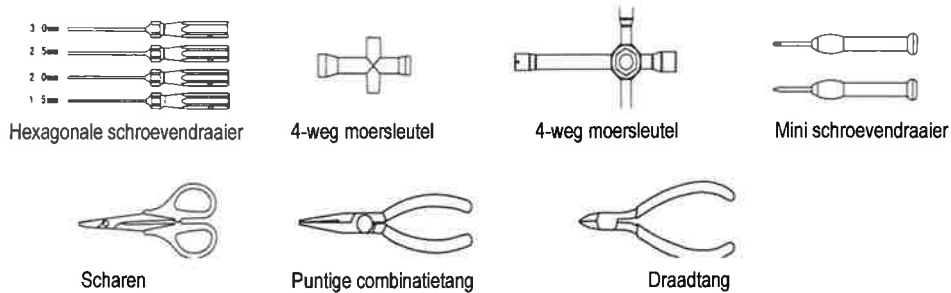

## ZENDER

De zender heeft 8 AA batterijen nodig.



Schuif het batterijklepje op om de batterijbehuizing te openen.

Sluit het batterijklepje nadat de 8AA batterijen zijn geplaatst.

### Batterij voorzorgsmaatregelen:

Wij raden het gebruik van 1,5V alkaline batterijen aan in plaats van de oplaadbare 1,2V batterijen.

Plaats niet met verkeerde polariteit.

Gebruik geen verschillende batterij-typen en mix geen oude en nieuwe batterijen.

Laat geen batterijen achter indien ze niet gebruikt worden voor een langere periode.

Vervang de batterijen wanneer de stroomindicatoren zwak zijn.

### Schakelaarfuncties van de zender:



## Hoe te rijden:



1. Trigger op de neutrale positie (stop)



2. Duw de trigger (vooruit)



3. Terug naar neutraal (vertragen)



4. Duw de trigger (remmen)



5. Laat de trigger los naar 6. Duw de trigger (achteruit) neutraal



### **AUTO-ZENDER BINDING:**

Standaard worden zenders en ontvangers al gebonden of verbonden. Zet de zender eerst gewoon aan, gevolgd door de auto en het zal werken. Indien nodig kan BINDING worden uitgevoerd door het volgen van deze eenvoudige instructies.

- Leg de batterijen in de zender zonder deze in te schakelen.
- Monteer de meegeleverde overbrugging op kanaal BIND/CH3 van de ontvanger.
- Verander de aansluiting die van de omzetter komt en die in positie CH2 stond, naar kanaal VCC.
- Schakel de batterij van de ontvanger in.
- Nu zal het lampje van de ontvanger beginnen knipperen. Dit betekent dat de ontvanger de frequentie aan het zoeken is.
- Houd de knop 'Bind' op de zender ingedrukt en schakel tegelijkertijd de zender in. Het groene lampje knippert nu.
- Het lampje van de ontvanger stopt nu met knipperen en blijft branden, wat betekent dat de ontvanger gesynchroniseerd is.
- Schakel de zender en de batterij van de ontvanger uit.
- Verwijder de overbrugging van kanaal BIND-CH3 van de ontvanger en monteer opnieuw de aansluiting van de omzetter op kanaal CH2.
- Schakel de zender opnieuw in. Nu zal het groene lampje stoppen met knipperen, wat betekent dat de synchronisatie correct is uitgevoerd.
- Als de synchronisatie niet correct is, herhaal dan het bovenstaande proces.

# NH93055 XTREM CRAWLER 2,4Ghz

NH93743 PAINTED BODY XTREM CRAWLER  
NH93746 TRANSMITTER 2,4 GHz

## FRONT

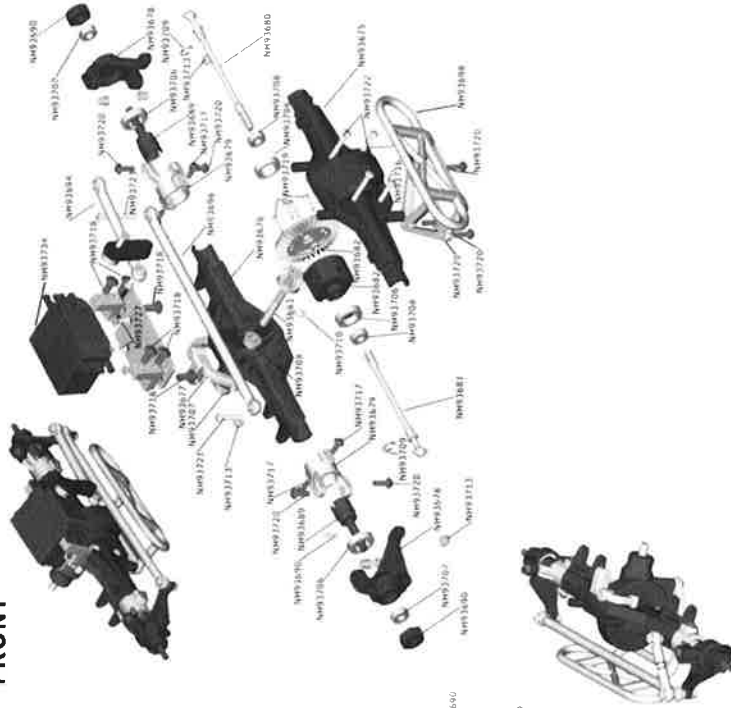

## REAR

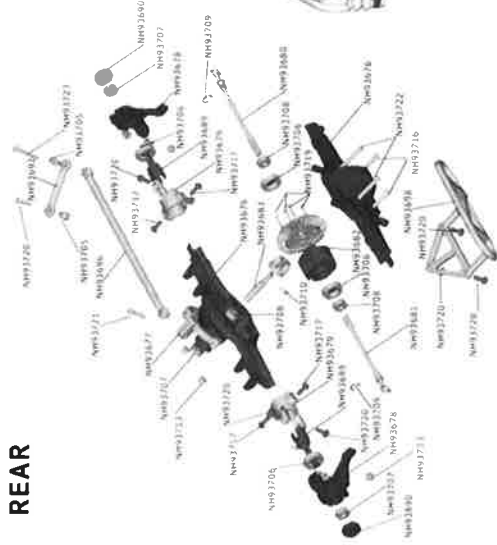

# NH93055 XTREM CRAWLER 2.4GHz

## 3. CENTER UNIT



## 4. WHEEL



## 5. SHOCK ABSORBER





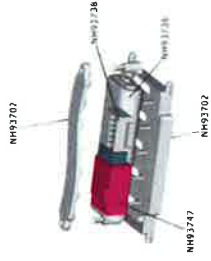



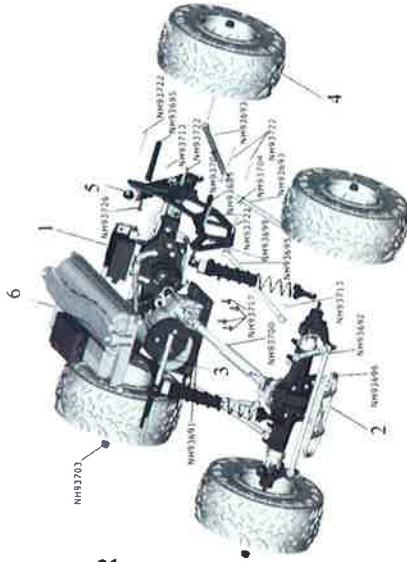
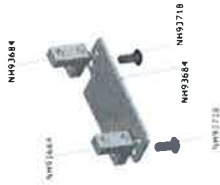









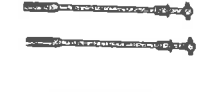



## 6. BATTERY SET







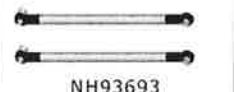

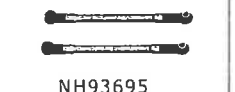
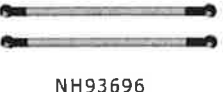













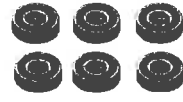

















## 7. SERVO MOUNT

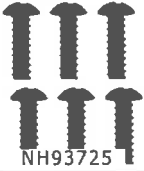

**1/10 XTREM CRAWLER SPARE PARTS**

<p>Front Gear Box</p>  <p>NH93675</p>	<p>Rear Gear Box</p>  <p>NH93676</p>	<p>Center Link Ball Mounts 2P</p>  <p>NH93677</p>	<p>Caster Mounts 2P</p>  <p>NH93678</p>
<p>Servo(9kg)</p>  <p>NH93734</p>	<p>Steering Arm(L/R)</p>  <p>NH93679</p>	<p>Drive Shaft(L) 2P</p>  <p>NH93680</p>	<p>Drive Shaft(R) 2P</p>  <p>NH93681</p>
<p>Connect Box w/main gear (38T)</p>  <p>NH93682</p>	<p>Drive Gear(13T)</p>  <p>NH93683</p>	<p>Servo Plate w/servo mount</p>  <p>NH93684</p>	<p>Body Post 4P</p>  <p>NH93685</p>
<p>Tire w/Foam 2P</p>  <p>NH93686</p>	<p>Rims/Secure Ring 2P</p>  <p>NH93687</p>	<p>Pre-Mounted Tire Set 2P</p>  <p>NH93688</p>	<p>Wheel Axle 2P</p>  <p>NH93689</p>
<p>Wheel Hex. W/Pins(2*10)</p>  <p>NH93690</p>	<p>Chassis</p>  <p>NH93691</p>	<p>Adjustable Linkage</p>  <p>NH93692</p>	
<p>Side Linkage (123.5mm) 2P</p>  <p>NH93693</p>	<p>Servo Linkage (60.23mm) 2P</p>  <p>NH93694</p>	<p>Center Linkage (96mm) 2P</p>  <p>NH93695</p>	<p>Connect Linkage (138mm) 2P</p>  <p>NH93696</p>

<p><b>Gear Box Set</b></p>  <p><b>NH93697</b></p>	<p><b>Bumper(F/R)</b></p>  <p><b>NH93698</b></p>	<p><b>Side Plate 2P</b></p>  <p><b>NH93699</b></p>	
<p><b>Universal Driven Dogbone 2P</b></p>  <p><b>NH93700</b></p>	<p><b>Shock Absorber 2P</b></p>  <p><b>NH93701</b></p>	<p><b>Battery Holder w/Covers</b></p>  <p><b>NH93702</b></p>	<p><b>NH93742</b> <b>PAINTED BODY</b> <b>XTREM CRAWLER</b></p>
<p><b>Receiver</b></p>  <p><b>NH93747</b></p>	<p><b>ESC</b></p>  <p><b>NH93738</b></p>	<p><b>Battery (NI-CH 7.2V 1800mAH)</b></p>  <p><b>NH93736</b></p>	<p><b>Motor(RC540) w/ Gear(14T)</b></p>  <p><b>NH93737</b></p>
<p><b>Nylon Nuts M4 8P</b></p>  <p><b>NH93703</b></p>	<p><b>Ball Stand <math>\phi 5.9</math> 6P</b></p>  <p><b>NH93704</b></p>	<p><b>Ball Stand <math>\phi 5.9</math> 8P</b></p>  <p><b>NH93705</b></p>	<p><b>Ball Bearings (10*15*4) 6P</b></p>  <p><b>NH93706</b></p>
<p><b>Ball Bearings (5*10*4) 8P</b></p>  <p><b>NH93707</b></p>	<p><b>Oil Bearings (5*10*4) 8P</b></p>  <p><b>NH93708</b></p>	<p><b>E-Clips 8P <math>\phi 4.0</math></b></p>  <p><b>NH93709</b></p>	<p><b>E-Clips 4P <math>\phi 2.5</math></b></p>  <p><b>NH93710</b></p>
<p><b>Washer 6*2.7*0.5 6P</b></p>  <p><b>NH93711</b></p>	<p><b>Nylon Nuts M2.5 8P</b></p>  <p><b>NH93712</b></p>	<p><b>Nylon Nuts M3 8P</b></p>  <p><b>NH93713</b></p>	<p><b>M3*3 4P</b></p>  <p><b>NH93714</b></p>

<p>Round Head Screw M3*12 8P</p>  <p>NH93715</p>	<p>Round Head Screw M3*14 6P</p>  <p>NH93716</p>	<p>Round Head Screw M3*8 8P</p>  <p>NH93717</p>	<p>Round Head Screw M4*8 8P</p>  <p>NH93718</p>
<p>Round Head Screw M2*10 6P</p>  <p>NH93719</p>	<p>Round Head Screw M3*10 8P</p>  <p>NH93720</p>	<p>Round Head Screw M3*16 6P</p>  <p>NH93721</p>	<p>Round Head Screw M3*20 6P</p>  <p>NH93722</p>
<p>Round Head Screw M3*25 4P</p>  <p>NH93723</p>	<p>Round Head Screw M3*24 6P</p>  <p>NH93724</p>	<p>Round Head Screw M3*26 6P</p>  <p>NH93725</p>	<p>Countersink screw M3*8 8P</p>  <p>NH93726</p>
<p>Countersink screw M3*10 8P</p>  <p>NH93727</p>	<p>Column Head Screw M2.5*5 8P</p>  <p>NH93728</p>	<p>Set Screw M3*20 6P</p>  <p>NH93729</p>	<p>Set Screw M3*15 6P</p>  <p>NH93730</p>
<p>UPGRADE PARTS</p>	<p>Rims/Secure Ring (AL.) 2P</p>  <p>NH93731</p>	<p>Front Gear Box (Shell Only) AL.</p>  <p>NH93732</p>	<p>Rear Gear Box (Shell only) AL.</p>  <p>NH93733</p>



# NH93008 - STONE CRAWLER 2,4 Ghz

Connect box with main gear assembly

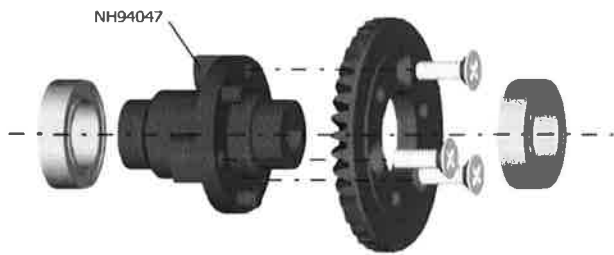

Servo arm assembly

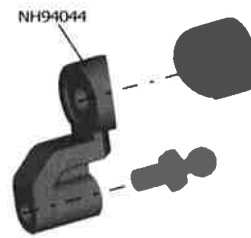

Servo mount assembly

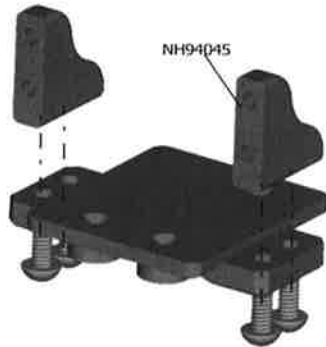

Adjustable linkage assembly

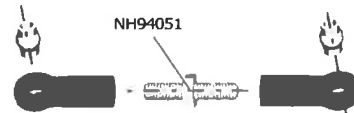

Servo link assembly

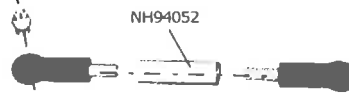

Side linkage



Center linkage

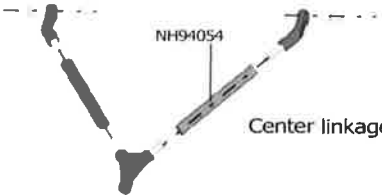

Dogbone

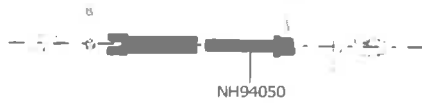

Shock absorber



# NH93052 - BOULDER CRAWLER 2.4GHz

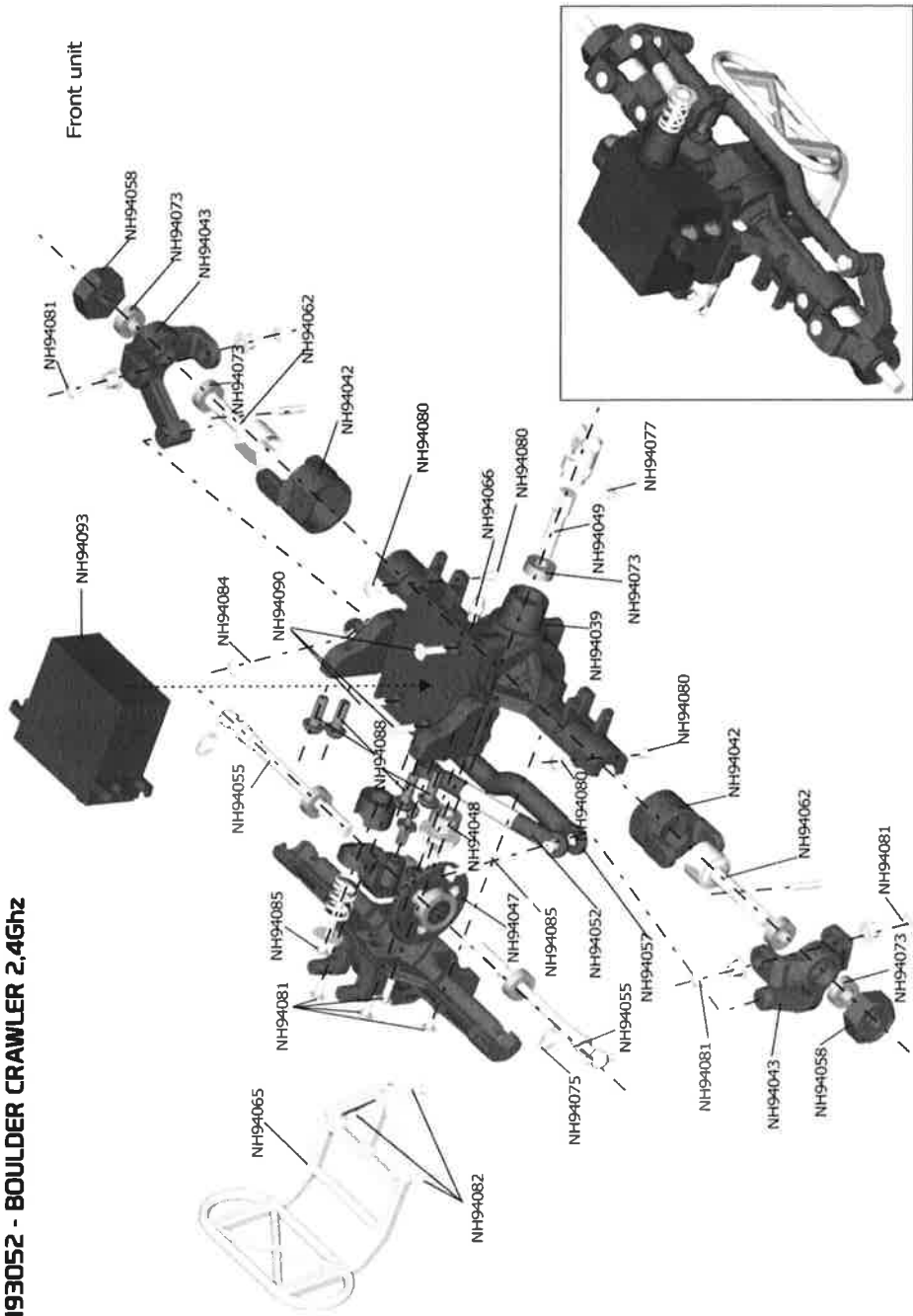



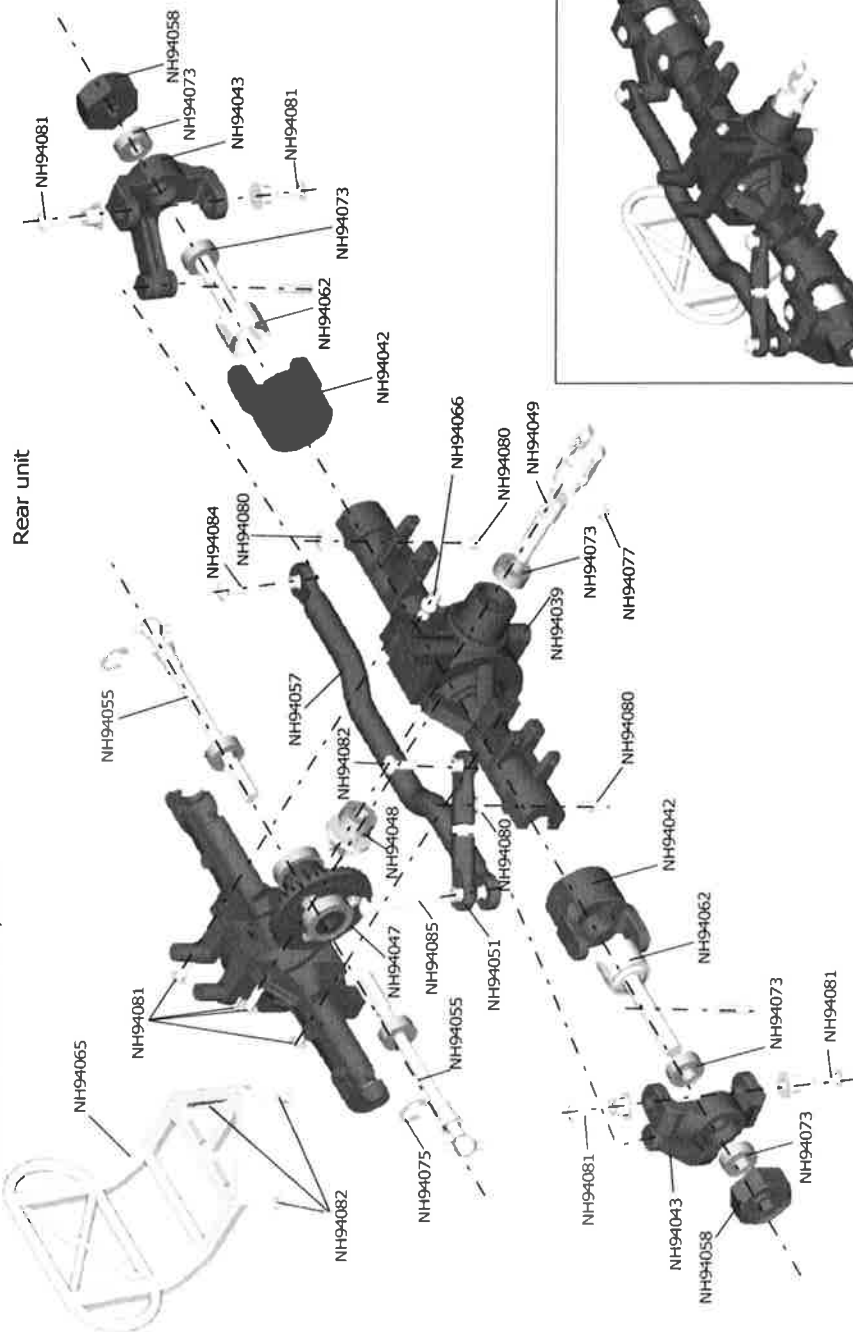

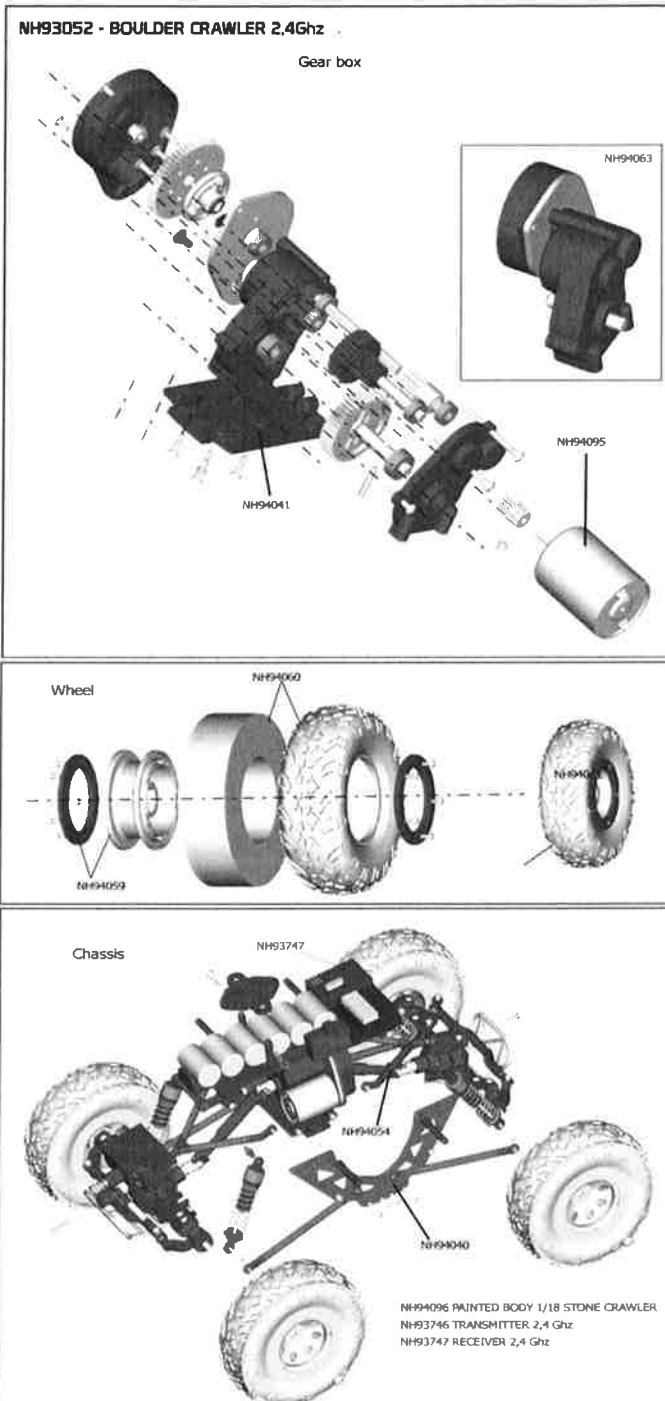























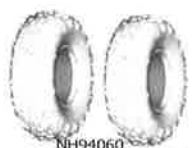
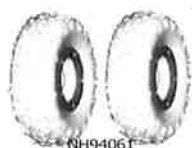



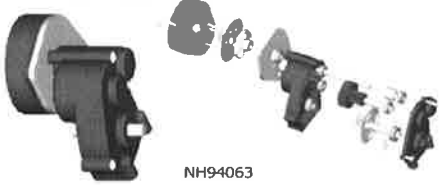
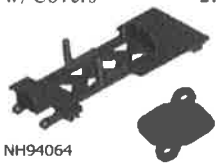





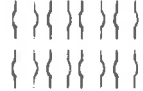



**NH93052 - BOULDER CRAWLER 2.4Ghz**











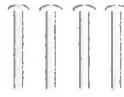
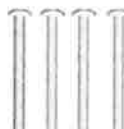

**1/18 BOULDER CRAWLER SPARE PARTS**

<p>F/R Gear Box</p>  <p>NH94039</p>	<p>Side Guard 2P</p>  <p>NH94040</p>	<p>Chassis</p>  <p>NH94041</p>	<p>Steering Mounts (L/R) 2P</p>  <p>NH94042</p>
<p>Steering Mounts (L/R) 2P</p>  <p>NH94043</p>	<p>Servo Arm</p>  <p>(2*6*0.5) NH94044</p>	<p>ServoPlate W/Servo Mount</p>  <p>NH94045</p>	<p>Shock Absorber 2P</p>  <p>NH94046</p>
<p>Connect Box w/main gear (38T)</p>  <p>NH94047</p>	<p>Drive Gear</p>  <p>NH94048</p>	<p>Drive shaft</p>  <p>NH94049</p>	<p>Universal Driven Dogbone 2P</p>  <p>NH94050</p>
<p>Adjustable Linkage</p>  <p>NH94051</p>	<p>Servo Linkage (41.27mm) 2P</p>  <p>NH94052</p>	<p>Side Linkage (86.9mm) 2P</p>  <p>NH94053</p>	<p>Center Linkage 2P</p>  <p>NH94054</p>
<p>Dogbone 4P</p>  <p>NH94055</p>	<p>Body Post 4P</p>  <p>NH94056</p>	<p>Connect Linkage 2P</p>  <p>NH94057</p>	<p>Wheel Hex. W/Pins (2*10) 4P</p>  <p>NH94058</p>
<p>Rim/Secure Ring 2P</p>  <p>NH94059</p>	<p>Tire w/Foam 2P</p>  <p>NH94060</p>	<p>Pre-Mounted Tire Set (L/R) 2P</p>  <p>NH94061</p>	<p>Wheel Axle 2P</p>  <p>NH94062</p>

<p><b>Gear Box</b></p>  <p>NH94063</p>		<p><b>Battery Holder w/ Covers</b> 2P</p>  <p>NH94064</p>		<p><b>Bumper(F/R)</b></p>  <p>NH94065</p>			
<p><b>Servo(1.7kg)</b></p>  <p>NH94093</p>		<p><b>ESC</b></p>  <p>NH94094</p>		<p><b>Battery (NI-CH 7.2V 1100mAH)</b></p>  <p>NH93867</p>		<p><b>Motor(RC260) w/ Gear(14T)</b></p>  <p>NH94095</p>	
<p><b>Ball Stand</b> <math>\Phi 4.0</math> 6P</p>  <p>NH94066</p>		<p><b>Ball Stand</b> <math>\Phi 4.0</math> 6P</p>  <p>NH94067</p>		<p>NH94096 PAINTED BODY STONE CRAWLER</p>		<p><b>Nylon Nuts M4</b> 8P</p>  <p>NH94068</p>	
<p><b>Nylon Nuts M3</b> 8P</p>  <p>NH94069</p>		<p><b>Nylon Nuts M2</b> 8P</p>  <p>NH94070</p>		<p><b>Ball Bearings (5*10*4)</b> 8P</p>  <p>NH94071</p>		<p><b>Ball Bearings (7*11*3)</b> 8P</p>  <p>NH94072</p>	
<p><b>Ball Bearings (4*8*3)</b> 8P</p>  <p>NH94073</p>		<p><b>E-Clips</b> 8P <math>\Phi 2.0</math></p>  <p>NH94074</p>		<p><b>E-Clips</b> 4P <math>\Phi 3.2</math></p>  <p>NH94075</p>		<p><b>Washer 2*6*0.5</b> 6P</p>  <p>NH94076</p>	
<p><b>Grub screw M3*3</b> 4P</p>  <p>NH94077</p>		<p><b>grub screw M4*3</b> 4P</p>  <p>NH94078</p>		<p><b>Set Screw M3*15</b> 6P</p>  <p>NH94079</p>		<p><b>Round Head Screw M2*4</b> 8P</p>  <p>NH94080</p>	

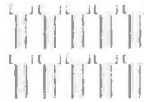
<p>Round Head Screw M2*6 8P</p>  <p>NH94081</p>	<p>Round Head Screw M2*8 6P</p>  <p>NH94082</p>	<p>Round Head Screw M2*12 4P</p>  <p>NH94083</p>	<p>Round Head Screw M2*14 4P</p>  <p>NH94084</p>
<p>Round Head Screw M2*20 4P</p>  <p>NH94085</p>	<p>Round Head Screw M2*27 8P</p>  <p>NH94086</p>	<p>Round Head Screw M2. 5*5 6P</p>  <p>NH94087</p>	<p>Round Head Screw M3*8 8P</p>  <p>NH94088</p>
<p>Countersink screw M2*6 8P</p>  <p>NH94089</p>	<p>Countersink screw M2*8 8P</p>  <p>NH94090</p>	<p>Column Head Screw M2*5 10P</p>  <p>NH94091</p>	

#### ESPAÑOL

Este es un producto complejo de hobby, no es un juguete. No recomendado para menores de 14 años. Debe ser usado con precaución y sentido común y requiere una un mínimo básico de habilidad para su pilotaje. No utilizar este producto de manera segura y responsable puede causar lesiones o daños en el propio producto u otras propiedades. Este producto no está recomendado para niños sin la estricta supervisión de un adulto. El manual del producto contiene instrucciones de seguridad, uso y mantenimiento. Es importante leer el manual y seguir las instrucciones y avisos que explica antes de manipularlo, prepararlo o usar para poder pilotarlo correctamente y evitar daños o lesiones.

#### ENGLISH

This is a sophisticated hobby product and not a toy. Children under the age of 14 are forbidden. It must be operated with caution and common sense and requires some basic mechanical ability. Failure to operate this product in a safe and responsible manner could result in injury or damage to the product or other property. This product is not intended for use by children without direct adult supervision. The product manual contains instructions for safety, operation and maintenance. It is essential to read and follow all the instructions and warnings in the manual, prior to assembly, setup or use, in order to operate correctly and avoid damage or injury.

#### PORTUGUES

Este é um produto completo de hobby, não é um brinquedo. Não recomendado para menores de 14 anos. Deve ser usado com precaução e sentido de responsabilidade, requer um mínimo básico de habituação para sua pilotagem. Não utilizar este produto de maneira insegura ou irresponsável, pode causar lesões ou danos no próprio produto ou em outras propriedades. Este produto não é recomendado para crianças sem a supervisão de um adulto. O manual do produto contém instruções de segurança, uso e manutenção. É importante ler o manual e seguir as instruções e avisos que explica antes de o manipular, preparando-o para usar, poder pilota-lo correctamente e evitar danos ou lesões.

#### DEUTSCH

Dieses Modell ist ein hochentwickeltes Hobbygerät, kein Spielzeug. Es ist für Kinder unter 14 Jahre nicht geeignet. Es sollte mit viel Vorsicht und gesundem Menschenverstand verwendet werden und um ihn zu steuern ist ein Minimum an Handfertigkeit notwendig. Eine nicht sichere und unverantwortliche Verwendung kann zu Schäden am Modell selber als auch an anderen Gegenständen führen. Dieses Gerät ist nicht für Kinder ohne strikte Überwachung durch einen Erwachsenen geeignet. Aus dem Handbuch zu diesem Modell gehen wichtige Hinweise zur Sicherheit, Verwendung und Wartung hervor. Daher sollten Sie dieses aufmerksam lesen und die darin enthaltenen Anweisungen und Hinweise beachten, bevor Sie das Modell vorbereiten und in Betrieb nehmen. Auf diese Weise werden Sie lernen, ihn korrekt zu steuern und Schäden oder Verletzungen zu vermeiden.

#### FRANÇAIS

Ceci est un produit sophistiqué de loisirs et non un jouet. Interdit aux enfants de moins de 14 ans. Il doit être utilisé avec précaution et bon sens, nécessite des connaissances de base en mécanique. Le fait de ne pas utiliser ce produit d'une manière sécuritaire et responsable peut provoquer des blessures ou des dommages au produit ou à d'autres biens. N'est pas adapté à une utilisation par des enfants sans la surveillance directe d'un adulte. Le manuel contient des instructions relatives à la sécurité, à l'utilisation et à l'entretien de ce produit. Il est essentiel de lire et de suivre toutes ces instructions et les avertissements avant assemblage, installation ou utilisation du produit afin de garantir un fonctionnement correct, sans causer de dommages ou de blessures.

#### NEDERLANDS

Dit is een geavanceerd hobbyproduct en geen speelgoed. Het gebruik voor kinderen jonger dan 14 jaar is verboden. Het moet met voorzichtigheid en gezond verstand bediend worden en vereist wat mechanische basisvaardigheden. Het niet op een juiste manier veilig en verantwoordelijk omgaan met dit product kan resulteren in letsel of schade aan het product of andere eigendommen. Dit product is niet bedoeld voor gebruik door kinderen zonder direct toezicht van volwassenen. De producthandleiding bevat instructies voor veiligheid, bediening en onderhoud. Het is essentieel om alle instructies en waarschuwingen in de handleiding op te volgen, voorafgaand aan de montage, de installatie of het gebruik, om te zorgen voor een juiste werking en de voorkoming van schade of letsel.



NINCO DESARROLLOS S.L. declara que este sistema de radiocontrol está en conformidad con los requisitos básicos de las correspondientes Directivas Europeas. La Declaración de Conformidad original se puede obtener accediendo a la sección **descargas** de la siguiente dirección web: **www.ninco.com**

NINCO DESARROLLOS S.L. hereby declares that this radio control system is in accordance with the basic requirements of the corresponding European Directives. The original Declaration of Conformity can be obtained clicking the **download** area in the following web address: **www.ninco.com**

**NINCO4RC**®

NINCO4RC is brand of NINCO DESARROLLOS S.L.  
Ctra. de l'Hospitalet 32  
08940 Cornellà Barcelona Spain  
CIF B-60307725 · www.ninco4rc.com



CE 0678



MADE IN CHINA