

# **NINCO4RC**

**NH93090**  
**“1/12 WARRIOR”**



**1/12 2WD RC ELECTRIC MONSTER RTR**

# **WARRIOR**

*MANUAL DEL USUARIO*  
*USER HANDBOOK*  
*MANUAL DO USUARIO*  
*HANDBUCH*  
*MANUEL DE L'UTILISATEUR*  
*MANUALE D'USO*

**SINCRONIZACIÓN (COCHE-EMISORA) / BINDING PROCESS (CAR - TRANSMITTER)**

**Coche y emisora están sincronizados.  
Car & Transmitter are already synchronized.  
Voiture et Émetteur sont déjà synchronisés.**

A continuación se describe el proceso por si fuera necesario realizarlo de nuevo:  
Below the binding process explanation in case you may need to do it again:  
Processus indiqué en bas soit qu'il faut le refaire à nouveau:

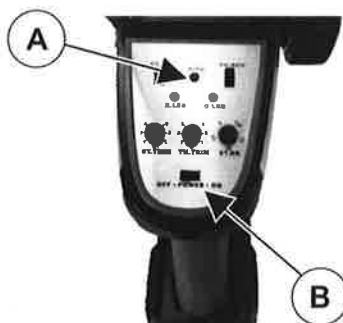

1- Mantener pulsado el botón BIND (A) al mismo tiempo que ponemos en marcha la emisora: ON (B)

*Press and hold "BIND" button (A) while we turn on the transmitter (B).*

Poussez le bouton « bind » sur l'émetteur et le (A) maintenir poussé à la fois que l'on allume l'émetteur. (B)

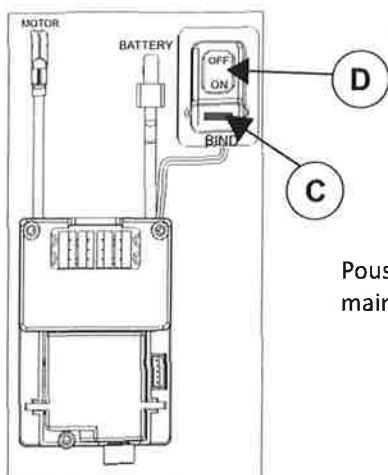

2- Mantener pulsado el botón BIND (C) al mismo tiempo que ponemos en marcha el coche: ON (D)

*Press and hold "BIND" button (C) while we turn on the car (D).*

Poussez le bouton « bind » sur la voiture et le (C) maintenir poussé à la fois que l'on branche la voiture. (D)

3- Espere... / Wait... 5"  
Attendez.....



4- Apagar coche y emisora. / Turn off car and transmitter.  
Eteignez la voiture et l'émetteur.

5- Encender emisora y coche... ¡ya están sincronizados! / Turn on transmitter and car... binding process is already done!  
Allumez l'émetteur et branchez la voiture... Ils sont déjà liés !

**Por favor, lea atentamente las instrucciones antes de manipular este vehículo.**

**ESPECIFICACIONES:**

**NH93090 1/12 MONSTER TRUCK 2,4 Ghz**

Longitud	Anchura	Altura	Dist. entre ejes	Relación	Altura chasis	Diámetro rueda	Anchura rueda (d/t)	Motor
345mm	245mm	140mm	275mm	1:8,2	32mm	90mm	45mm	Rc380

**CONTENIDO:**

Artículos necesarios para el funcionamiento del vehículo, incluidos en el set:



- Coche
- Emisora 2,4Ghz
- Motor
- PBC 3-1 (Servo-ESC-RX)
- Batería Li-Po 7,4v 1500mAh
- Requiere 4 pilas AA

**NOTA:**

-Cargar la batería durante 8 o 10 horas antes de su primer uso.  
No dejarla desatendida durante el proceso de carga.

-Cuando el coche está bloqueado, no continuar activando el gatillo. Puede sobrecalentar y dañar el variador.

**Los siguientes artículos, no incluidos en el set, son necesarios para la manipulación y mantenimiento del vehículo:**

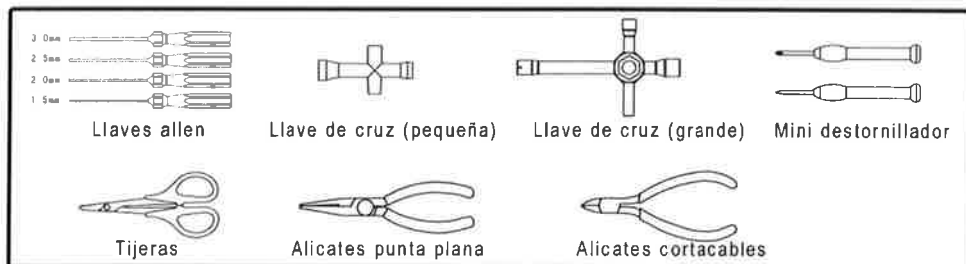

## LA EMISORA

La emisora requiere 4 pilas AA para su funcionamiento.



Retira la tapa para acceder al compartimiento de las pilas.

Vuelve a poner la tapa una vez las pilas ya colocadas.

### Precaución con las pilas:

Se recomienda el uso de pilas alcalinas de 1,5v en lugar de recargables de 1,2v.

Vigile la correcta colocación de la polaridad

No usar baterías de diferentes tipos ni mezclar nuevas y usadas.

Retirar las pilas si no va a usar la emisora en un largo periodo de tiempo.

Sustituya las pilas según marque el indicador de nivel.

### Funciones de la emisora:

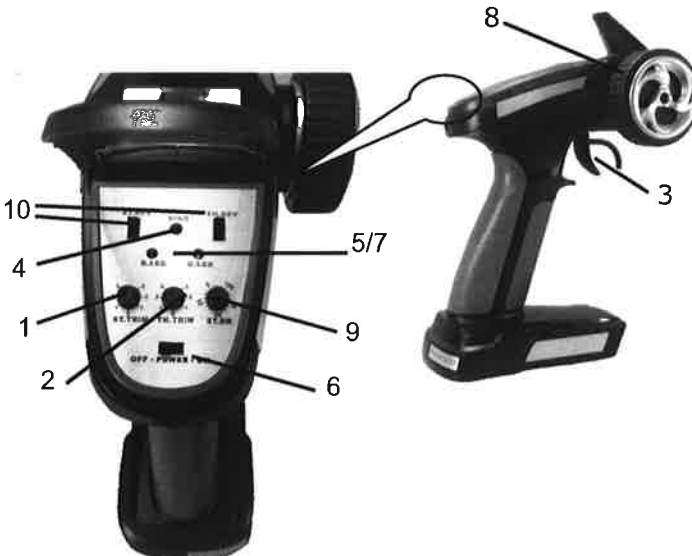

1. Trim dirección
2. Trim acelerador
3. Gatillo acelerador
4. Botón asociación
5. Indicadores potencia
6. Interruptor encendido
7. Led encendido
8. Control dirección
9. Dual rate dirección
10. Inversor servos

## Cómo conducir:



1. Gatillo en posición neutra (coche parado)



2. Apretar gatillo (marcha adelante)



3. Volver a neutro (desaceleración)



4. Abrir gatillo (freno en seco)



5. Dejar de nuevo en neutro (activa el variador)



6. Abrir gatillo (marcha atrás)

Please read carefully the instructions before using the car.

**FEATURES:**

**NH93090 – 1/12 MONSTER TRUCK 2,4 Ghz**

Length	Width	Height	Wheel base	Gear ratio	Ground clearance	Wheel diameter	Wheel width	Motor
345mm	245mm	140mm	275mm	1:8,2	32mm	90mm	45mm	Rc380

**CONTENTS:**

Items needed for running



- Car
- Transmitter 2,4Ghz
- Motor
- PBC 3-1 (Servo-ESC-RX)
- Battery Li-Po 7,4v 1500mAh
- 4 AA batteries required

**NOTE:**

-Charge the battery for 8-10 hours for the first time usage. Do not charge the battery unattended.

-When the car is blocked, do not continue to pull/push the trigger, this will cause the ESC to overheat and damage the ESC

The following items, not included in the kit, are required for assembling your model:

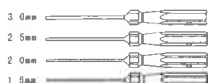

Hexagonal screwdriver

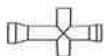

4-way cross wrench

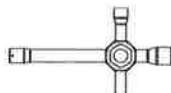

4-way cross wrench

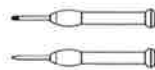

mini screwdriver



Scissors

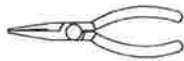

Alloyed steel  
needle nose cutter



Alloyed steel  
Wire cutter

# TRANSMITTER

The transmitter requires 4 AA batteries.



Slide the battery cover to open the battery compartment.

Replace the battery cover after AA batt. are installed.

## Battery precautions:

We recommend to use the 1,5V alkaline batteries instead of the 1.2V chargeable batteries.

Do not install with wrong polarities.

Do not use batteries of different types and do not mix old and new batteries.

Do not leave batteries if not in use for a long period.

Please replace batteries when power indicators are weak

## Function switches of the transmitter:



- 1. Steering trim
- 2. Throttle trim
- 3. Trigger
- 4. Biding
- 5. Power indicator
- 6. Switch on-off
- 7. On-off indicator
- 8. Control wheel
- 9. Steering Dual rate
- 10. Inversor servos

## How to drive:



1. Trigger at the neutral position (stop)



2. Pull the trigger (forward) (decelerate)



3. Back to neutral



4. Push the trigger (breaking)



5. Release the trigger to neutral



6. Push the trigger (backwards)



**Por favor, lea atentamente as instruções antes de manipular este veículo.**

**ESPECIFICACÕES:**

**NH93090 – 1/12 MONSTER TRUCK 2,4 Ghz**

Cumprimento	Largura	Altura	Dist. entre eixos	Relação	Altura chasis	Diâmetro roda	Altura roda	Motor
345mm	245mm	140mm	275mm	1:8,2	32mm	90mm	45mm	Rc380

**CONTEUDO:**

Artigos necesarios para o funcionamento del vehículo, incluidos no set:



- Coche
- Emisora 2,4Ghz
- Motor
- PBC 3-1 (Servo-ESC-RX)
- Bateria Li-Po 7,4v 1500mAh
- Requiere 4 pilas AA

**NOTA**

-Carregar a bateria durante 8 a 10 horas antes de seu primeiro uso. Durante o proceso de carga, supervise a bateria.

-Quando o carro está bloqueado, não continuar activando o gatillo. Pode sobreaquecer e danificar o variador.

**Os seguintes artigos, não incluídos no set, são necessários para a manipulação e montagem do veículo:**

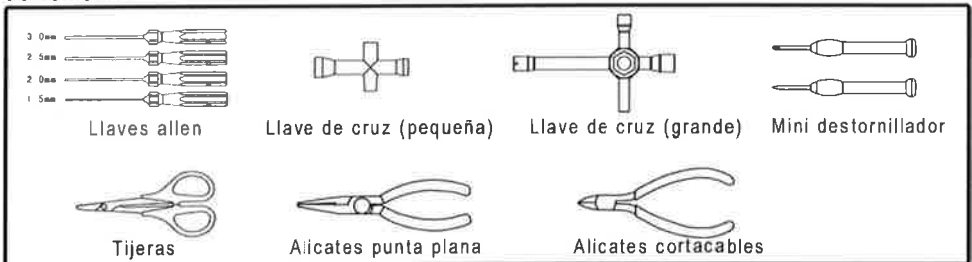

## O EMISOR

O emisor requer 4 pilhas AA para o seu funcionamento.



Retira a tampa para aceder ao compartimento das pilhas.

Volta a por a tampa uma vez as pilhas já colocadas.

### Precaução com as pilhas:

Recomenda-se o uso de pilhas alcalinas de 1,5v em lugar de recarregáveis de 1,2v.

Verifique a correcta colocação da polaridade.

Não usar baterias de diferentes tipos nem misturar novas e usadas.

Retirar as pilhas se não vai usar o emisor por um longo periodo de tempo.

Substitua as pilhas quando o nivel indicar.

### Funções do emisor

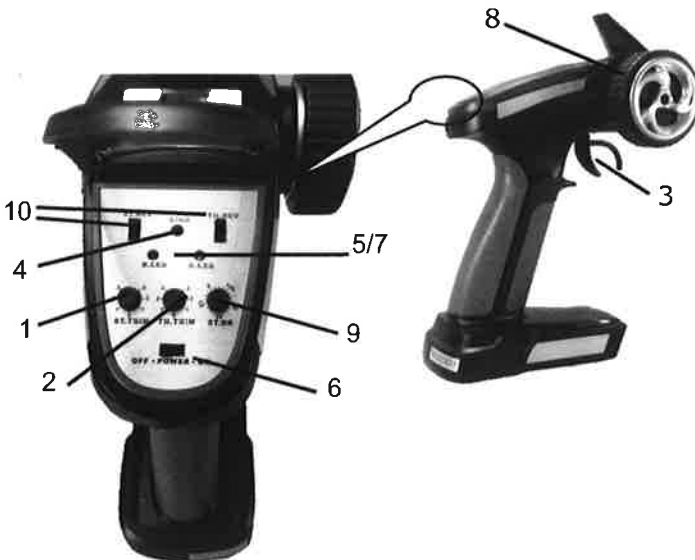

1. Direcção trim
2. Acelerador trim
3. Gatilho
4. Biding
5. Indicadores potencia
6. Interruptor para ligar
7. Indicador On-off
8. Control direcção
9. Dual rate direcção
10. Inversor servos

## Como conduzir:



1. Gatilho em posição neutra  
(carro parado)



2. Apertar gatilho  
(marcha frente) (desaceleração)



3. Voltar a neutro



4. Empurrar gatilho  
(trava em seco)



5. Deixar de novo em  
neutro (activa o variador)



6. Empurrar gatilho  
(marcha atrás)

Bitte lesen Sie aufmerksam diese Anleitung bevor Sie das Modell benutzen

**EIGENSCHAFTEN:**

**NH93090 – 1/12 MONSTER TRUCK 2,4 Ghz**

Länge	Breite	Höhe	Radstand	Ratio	Bodenfreiheit	Raddurchmesser	Reifenbreite	Motor
345mm	245mm	140mm	275mm	1:8,2	32mm	90mm	45mm	Rc380

**INHALT:**

Ausstattung des Modells Benötigte Teile um das Modell zu benutzen (enthalten):



- Farzeugh
- Sender 2,4Ghz
- Motor
- PBC 3-1 (Servo-ESC-RX)
- Batterie Li-Po 7,4v 1500mAh
- 4 pilas AA (nitch enthalten)

**ACHTUNG:**

- Laden Sie den Akku das erste mal 8-10 Stunden auf bevor Sie Ihn benutzen. Lassen Sie Ihn dabei nicht unbeaufsichtigt
- Wenn etwas das Modell blockiert, geben Sie kein Gas mehr, dieses kann den Fahrregler überhitzen und zerstören

Die folgenden Teile (nicht enthalten) werden benötigt:

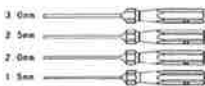

Inbus Schraubendreher

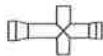

4-Wege Schraubenschlüssel

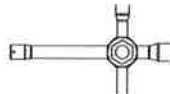

4-Wege Schraubenschlüssel

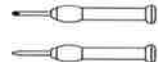

Mini Schraubendreher



Schere

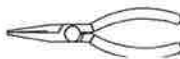

Cutter Messer

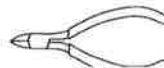

Seitenschneider

## SENDER:

Der Sender benötigt 4 AA Batterien.



Schieben Sie den Batteriedeckel auf um an die Halterungen zu gelangen.

Schließen Sie den Batteriedeckel nachdem Sie die Batterien eingelegt haben.

### Vorsichtsmaßnahmen:

Wir empfehlen die Verwendung von 1,5V Alkaline Batterien anstelle von 1,2V Akkus.

Achten Sie auf die richtige Polarität

Verwenden Sie keine unterschiedlichen Batterien gleichzeitig

Nehmen Sie die Batterien aus dem Sender wenn Sie ihn länger nicht benutzen

Tauschen Sie die Batterien aus wenn diese nicht mehr die volle Leistung haben.

### Funktionen des Senders:



- 1. Steuerungs Feineinstellung
- 2. Gas/Bremse Feineinstellung
- 3. Abzug
- 4. Binding
- 5. Betriebs LED
- 6. An/Aus Schalter
- 7. Status LED
- 8. Steuerungsrad
- 9. Dual rate Steuerung
- 10. Servo Umrichter

## Fahranleitung:



1. Abzug in Neutralstellung  
(Stop) (Vorwärts)



2. Ziehen des Abzugs  
(Gas wegnehmen)



3. Zurück zu Neutral



4. Drücken des Abzugs  
(Bremsen)



5. Loslassen des Abzugs  
(Neutral Position)



6. Drücken des Abzugs  
(Rückwärts)

**Veillez lire attentivement les instructions avant d'utiliser la voiture.**

## SPECIFICATIONS:

### NH93090 – 1/12 MONSTER TRUCK 2,4 Ghz

Longueur	Largeur	Hauteur châssis	Entrave	Rapport d'engrenage	Garde au sol	Diamètre de roue	Largeur de roue	Moteur
345mm	245mm	140mm	275mm	1:8,2	32mm	90mm	45mm	Rc380

## CONTENU:

Éléments nécessaires au fonctionnement de votre voiture (inclus):



Voiture  
 Emetteur 2,4Ghz  
 Motor  
 PBC 3-1 (Servo-ESC-RX)  
 Batterie Li-Po 7,4v 1500mAh  
 4 piles AA (non inclusées)

### NOTE:

- Rechargez la batterie pendant 8-10 heures lors de la première utilisation. Ne laissez pas la batterie sans surveillance pendant la charge.
- Lorsque la voiture est bloquée, n'appuyez pas sur la gâchette, car l'ESC risque de surchauffer et de s'endommager.

**Les éléments suivants, non inclus dans le kit, sont nécessaires au montage de votre voiture.**

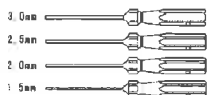

Tournevis hexagonal

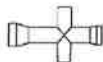

Clé en croix

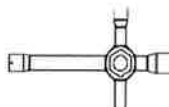

Clé en croix

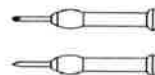

Tournevis miniature

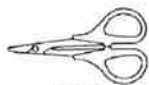

Ciseaux

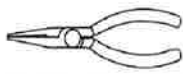

Alésage pointe plane  
 Pince à bec



Alésage pontonnettes  
 Coupe-câbles

## ÉMETTEUR

L'émetteur nécessite 4 piles AA.



Faites glisser le couvercle des piles pour ouvrir le compartiment à piles.

Remettez le couvercle des piles après avoir installé les piles.

### Précautions concernant les piles:

Nous vous recommandons d'utiliser des piles alcalines 1,5V plutôt que des piles rechargeables 1,2V.

Respectez les polarités.

Ne mélangez pas différents types de piles ou des piles neuves avec des piles usagées.

Enlevez les piles en cas de non-utilisation prolongée.

Remplacez les piles lorsque les indicateurs de puissance sont faibles.

### Commandes des fonctions de l'émetteur:



1. Trim de direction
2. Trim d'accélération
3. Gâchette
4. Liason
5. Indicateur de puissance
6. Interrupteur on-off
7. Indicateur On-Off
8. Molette de contrôle
9. Dual Rate direction
10. Inverseur servos



## Comment conduire:



1. Gâchette au point mort (stop) 2. Tirez la gâchette  
(marche ~~avant~~) (décélérer)

3. Retour au point



4. Poussez la gâchette (freiner)  
retour au point mort  
arrière)

5. Relâchez la gâchette pour  
gâchette (marche

6. Poussez la

**Leggere attentamente le istruzioni prima di usare l'auto**

## CARATTERISTICHE:

### NH93090 – 1/12 MONSTER TRUCK 2,4 Ghz

Lunghezza	Larghezza	Altezza	Interasse	Rapporto di trasmissione	Altezza da terra	Diametro della ruota	Larghezza della ruota	Motore
345mm	245mm	140mm	275mm	1:8,2	32mm	90mm	45mm	Rc380

## CONTENUTI:

Articoli necessari per il funzionamento



Auto  
Trasmettitore 2,4Ghz  
Motore  
PBC 3-1 (Servo-ESC-RX)  
Batteria Li-Po 7,4v 1500mAh  
Requisiti batterie: 4 nel formato AA

### ATTENZIONE:

-Caricare la batteria per 8-10 ore per il primo utilizzo. Non lasciare la batteria incustodita mentre è in carica.

-Quando l'auto è bloccata, non si deve continuare a tirare/spingere il grilletto, ciò causerà il surriscaldamento e il guasto dell' ESC.

**I seguenti articoli, non inclusi nel kit, sono necessari per assemblare il vostro modello.**

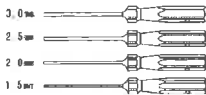

Cacciavite esagonale

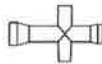

Chiave a croce a 4 vie

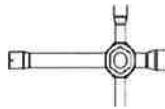

Chiave a croce a 4 vie

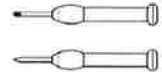

Mini giravite



Forbici

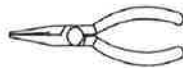

Taglierina a punta

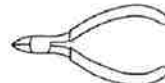

Pinza tagliafilii

Il trasmettitore necessita di 4 batterie AA



Fare scivolare il coperchio della batteria per aprire il vano batterie.

Riposizionare il coperchio dopo avere installato le batterie AA.

### Consigli sull'uso delle batterie:

Si raccomanda di utilizzare le batterie alcaline invece di quelle ricaricabili da 1,2v. Installare le batterie rispettandone la polarità.

Non usare batterie di diverso tipo e non mischiate le vecchie batterie con le nuove.

Rimuovere le batterie dal prodotto se non viene utilizzato per un lungo periodo di tempo.

Sostituire le batterie quando gli indicatori di potenza sono deboli.

### Interruttori funzionali del trasmettitore:

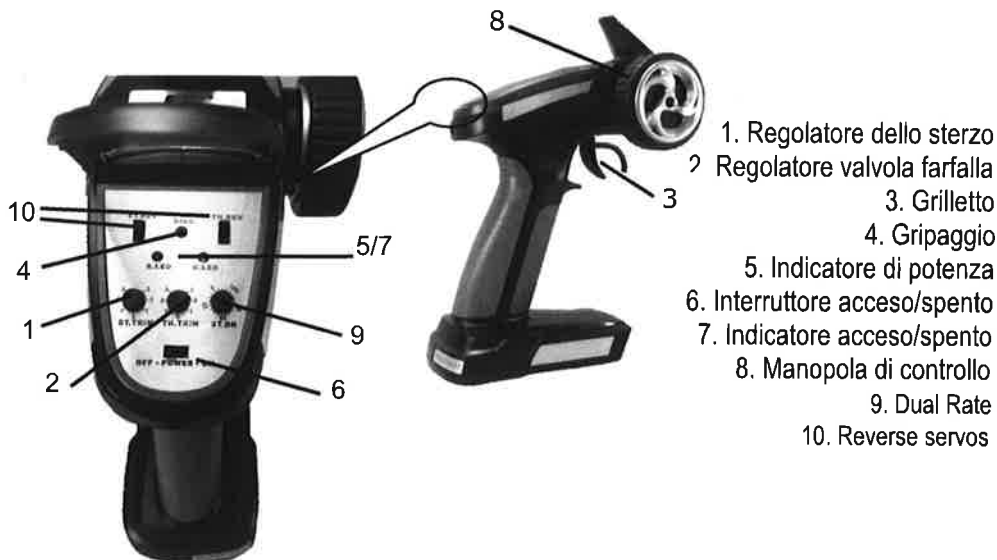

## Come guidare:



1. Grilletto in posizione neutra  
(stop) (avanti) (rallentare)



2. Tirare il grilletto



3. Ritornare alla posizione neutra



4. Spingere il grilletto  
(interruzione)















5. Rilasciare il grilletto e ritornare  
alla posizione neutra



6. Spingere il grilletto.  
(indietro)

## Spare Parts

NH94776- Chassis 	NH94777- Front Bumper 	NI194778-Front Lower Suspension Arm 	NH94779-Rear Lower Suspension Arm 
NI194780- Front Shock Absorber 	NH94781-Rear Shock Absorber 	NH94782-Front Shock Tower 	NH94783-Sheek Bracket 
NI194784-Front triangle Plat 	NH94785-Aim Block 	NH94786-Steering Mounts 	NH94787-Front Hub Carrier 
NH94788-Rear Upright 	NH94789-Gear Box Housing 	NI194790-Front wheel Axle 	NI194791-Rear Wheel Axle 
NH94792-Front Upper Link A 	NI194793-Steering Link B 	NH94794-Rear Upper Link C 	NI194795-Servo Link 
NH94796-Dogbones 	NH94797-Servo Saver Set 	NH94798- Double Gear (131/45T) 	NI194799-Diff Main Gear(33T) 
NI194800-Complete Diff. Set 	NI194801-Motor Gear ( 14T) 	NH94802-Planetary Gear Set 	NI194803-Differential Box+Seals+Washers 
NH93528-Universal Joint Cup C 		NH94805-Rear Suspension Arm Plaic 	NH94529-Pin 2*10mm 
NH94806-Pin 3*20 	NI194808-R- Clip 	NI194809 - R- Clip 	

<p>NH94948-Wheels Complete Set</p> 	<p>NH94825- Rear Roll Cage</p> 	<p>NH94826-body plates</p> 	<p>NH94829-Body Post</p> 	
<p>NH94814-Wheel Hex</p> 	<p>NH94815-Oil Bearing 6*3*2.5mm</p> 	<p>NH93767-Oil Bearing <math>\phi 10 \times \phi 5 \times 4</math></p> 	<p>NH94816-Ball Bearing <math>\phi 15 \times \phi 10 \times 4</math></p> 	<p>NH93534-Nylon Locknut M4</p> 
<p>NH94817-Link Ball Stud</p> 	<p>NH93547-Round Philips Button-Tapping Screw 2*10 10P</p> 	<p>NH94818-Round Philips Button-Tapping Screw 2.6*10 8P</p> 	<p>NH94819-Round Philips Button-Tapping Screw 2.6*16 8P</p> 	<p>NH94405-Countersunk Philips Tapping Screws 2.6*8 8P</p> 
<p>NH94464-Countersunk Philips Screw 2.5*6 6P</p> 	<p>NH94820-Button Head Screw 2.5*25 4P</p> 	<p>NH94821-Button Head Screw 2.5*34 4P</p> 	<p>NH94087-Button Head Machine Screw 2.5*6 6P</p> 	<p>NH93812-Button Head Self Tapping Screws 2.6*8 10P</p> 
<p>NH93811-Button Head Self Tapping Screws 2.6*6 14P</p> 	<p>NH94807-E-Clip <math>\phi 2.5</math> 8p</p> 	<p>NH93868-Motor 380</p> 	<p>NH94822-Radio PCB (HSC+Receiver+Servo) (Optional)</p> 	<p>NH94823-LiPO Battery (7.4V 1500mAh)</p> 
<p>NH94824-Charger</p> 	<p>NH94833-Transmitter</p> 			

### 1 Diff.Main Gear Complete Assembly

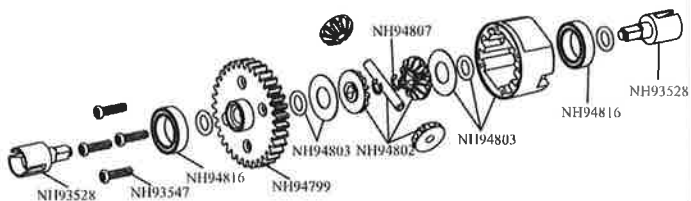

### 2 Gear Box Assembly

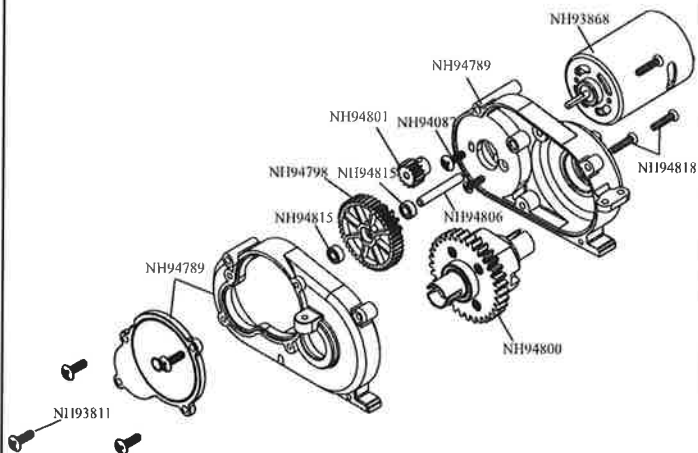

### 3 Rear Upright Assembly

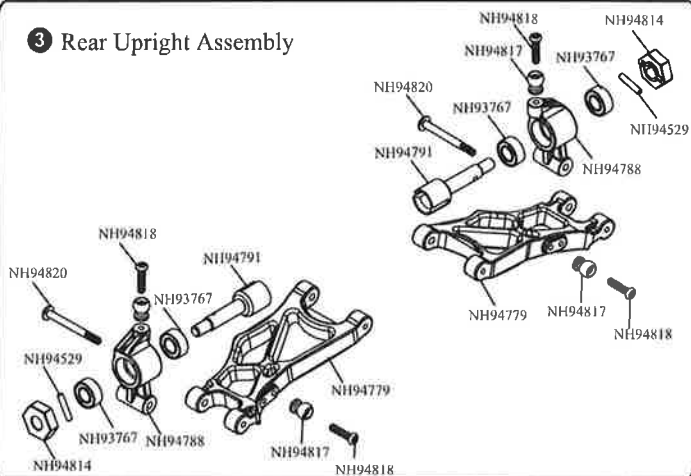

#### 4 Front Lower Suspension Arms Assembly

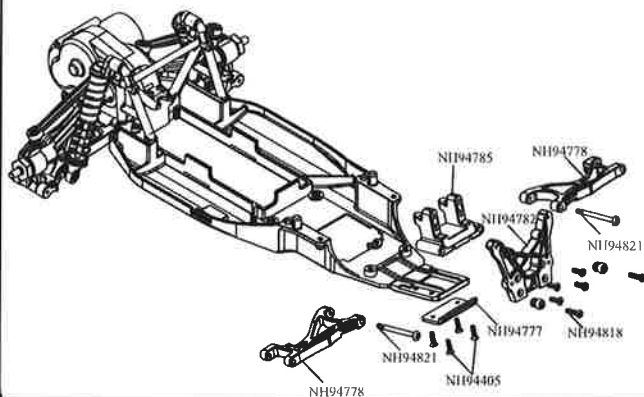

#### 5 Front steering Assembly

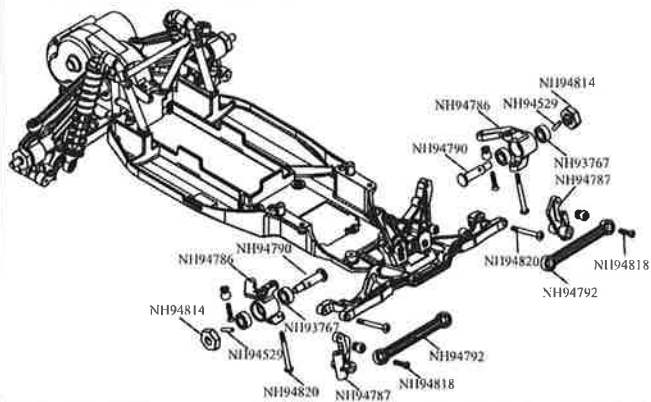

#### 6 Servo Saver Set Assembly

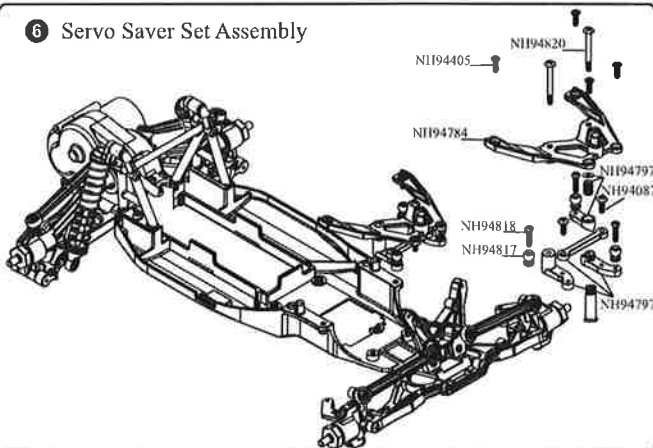



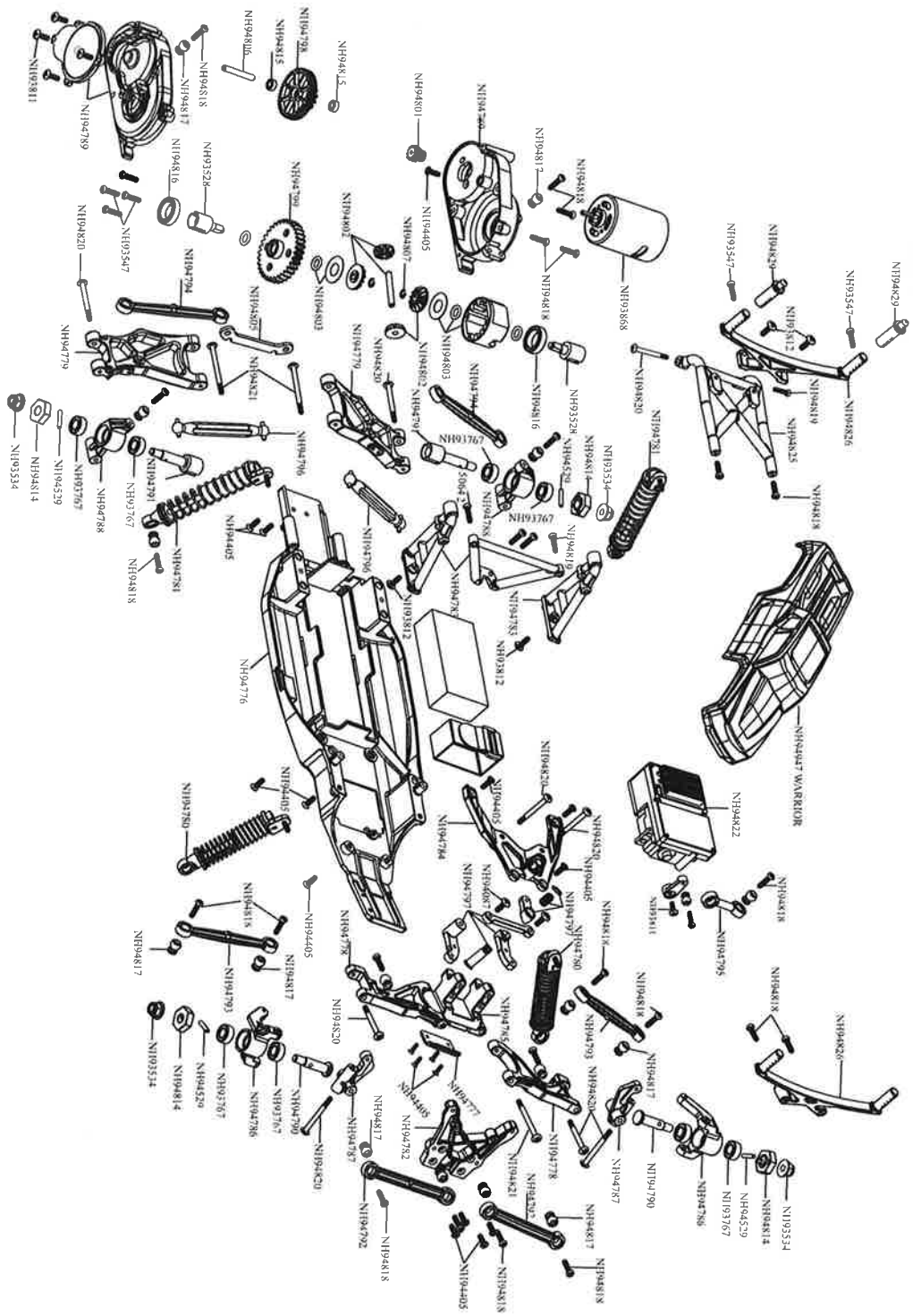

## ESPAÑOL

Este es un producto complejo de hobby, no es un juguete. No recomendado para menores de 14 años. Debe ser usado con precaución y sentido común y requiere un mínimo básico de habilidad para su pilotaje. No utilizar este producto de manera segura y responsable puede causar lesiones o daños en el propio producto u otras propiedades. Este producto no está recomendado para niños sin la estricta supervisión de un adulto. El manual del producto contiene instrucciones de seguridad, uso y mantenimiento. Es importante leer el manual y seguir las instrucciones y avisos que explica antes de manipularlo, prepararlo o usar para poder pilotarlo correctamente y evitar daños o lesiones.

## ENGLISH

This is a sophisticated hobby product and not a toy. Children under the age of 14 are forbidden. It must be operated with caution and common sense and requires some basic mechanical ability. Failure to operate this product in a safe and responsible manner could result in injury or damage to the product or other property. This product is not intended for use by children without direct adult supervision. The product manual contains instructions for safety, operation and maintenance. It is essential to read and follow all the instructions and warnings in the manual, prior to assembly, setup or use, in order to operate correctly and avoid damage or injury.

## PORTUGUES

Este é um produto completo de hobby, não é um brinquedo. Não recomendado para menores de 14 anos. Deve ser usado com precaução e sentido de responsabilidade, requer um mínimo básico de habitação para sua pilotagem. Não utilizar este produto de maneira insegura ou irresponsável, pode causar lesões ou danos no próprio produto ou em outras propriedades. Este produto não é recomendado para crianças sem a supervisão de um adulto. O manual do produto contém instruções de segurança, uso e manutenção. É importante ler o manual e seguir as instruções e avisos que explica antes de o manipular, preparando-o para usar, poder pilota-lo corretamente e evitar danos ou lesões.

## DEUTSCH

Dieses Modell ist ein hochentwickeltes Hobbygerät, kein Spielzeug. Es ist für Kinder unter 14 Jahre nicht geeignet. Es sollte mit viel Vorsicht und gesundem Menschenverstand verwendet werden und um ihn zu steuern ist ein Minimum an Handfertigkeit notwendig. Eine nicht sichere und unverantwortliche Verwendung kann zu Schäden am Modell selber als auch an anderen Gegenständen führen. Dieses Gerät ist nicht für Kinder ohne strikte Überwachung durch einen Erwachsenen geeignet. Aus dem Handbuch zu diesem Modell gehen wichtige Hinweise zur Sicherheit, Verwendung und Wartung hervor. Daher sollten Sie dieses aufmerksam lesen und die darin enthaltenen Anweisungen und Hinweise beachten, bevor Sie das Modell vorbereiten und in Betrieb nehmen. Auf diese Weise werden Sie lernen, ihn korrekt zu steuern und Schäden oder Verletzungen zu vermeiden.

## FRANÇAIS

Ceci est un produit sophistiqué de loisirs et non un jouet. Interdit aux enfants de moins de 14 ans. Il doit être utilisé avec précaution et bon sens, nécessite des connaissances de base en mécanique. Le fait de ne pas utiliser ce produit d'une manière sécuritaire et responsable peut provoquer des blessures ou des dommages au produit ou à d'autres biens. N'est pas adapté à une utilisation par des enfants sans la surveillance directe d'un adulte. Le manuel contient des instructions relatives à la sécurité, à l'utilisation et à l'entretien de ce produit. Il est essentiel de lire et de suivre toutes ces instructions et les avertissements avant assemblage, installation ou utilisation du produit afin de garantir un fonctionnement correct, sans causer de dommages ou de blessures.

## ITALIANO

Questo sofisticato articolo per il tempo libero non è un giocattolo. Non è adatto per bambini con meno di 14 anni. Deve essere utilizzato con molta cautela e con buon senso. Per il comando a distanza è richiesta un minimo di manualità. L'utilizzo insicuro e irresponsabile può provocare danni allo stesso modello e danneggiare anche altre cose. Questo articolo non può essere utilizzato da bambini senza la sorveglianza e la guida di un adulto. Il manuale d'uso specifica molte indicazioni per la sicurezza, per l'uso e per la manutenzione. Per questa ragione è molto importante seguire le indicazioni di il manuale d'uso e pertanto è importantissimo leggerlo con attenzione e seguirne scrupolosamente sia le istruzioni che le indicazioni in esso contenuto prima di metterlo in funzione. Solo in questo modo riuscirete ad imparare di comandarlo correttamente evitando danni o ferimenti.

## NOTES

NINCO DESARROLLOS S.L. declara que este sistema de radiocontrol está en conformidad con los requisitos básicos de las correspondientes Directivas Europeas. La Declaración de Conformidad original se puede obtener accediendo a la sección **descargas** de la siguiente dirección web: **www.ninco.com**

NINCO DESARROLLOS S.L. hereby declares that this radio control system is in accordance with the basic requirements of the corresponding European Directives. The original Declaration of Conformity can be obtained clicking the **download** area in the following web address: **www.ninco.com**

**Español [Spanish]:**

Por medio de la presente NINCO DESARROLLOS S.L. declara que el equipo de radio control cumple con los requisitos esenciales y cualesquiera otras disposiciones aplicables o exigibles de la Directiva 1999/5/CE.

**English:**

Hereby, NINCO DESARROLLOS S.L., declares that this Radio Control Equipment is in compliance with the essential requirements and other relevant provisions of Directive 1999/5/EC.

**Português [Portuguese]:**

NINCO DESARROLLOS S.L. declara que este Radio Control Equipment está conforme com os requisitos essenciais e outras disposições da Directiva 1999/5/CE.

**Deutsch [German]:**

Hiermit erklärt NINCO DESARROLLOS S.L., dass sich das Gerät Radio Control Equipment in Übereinstimmung mit den grundlegenden Anforderungen und den übrigen einschlägigen Bestimmungen der Richtlinie 1999/5/EG befindet.

**Français [French]:**

Par la présente NINCO DESARROLLOS S.L. déclare que l'appareil de Radio Control est conforme aux exigences essentielles et aux autres dispositions pertinentes de la directive 1999/5/CE.

**Italiano:**

Con la presente, la NINCO DESARROLLOS S.L. dichiara che questa attrezzatura di Radio Controllo è conforme ai requisiti essenziali e a qualsiasi altra disposizione applicabile o richiesta dalla Direttiva 1999/5/CE

Para más información sobre este producto, visite: [www.ninco.com/aprende](http://www.ninco.com/aprende)  
For more information on this product, visit: [www.ninco.com/aprende](http://www.ninco.com/aprende)

SERVICIO TÉCNICO ONLINE: PARA GARANTÍA Y ATENCIÓN AL CLIENTE VISITE [www.ninco.com](http://www.ninco.com)  
ONLINE CUSTOMER SERVICE AND WARRANTY VISIT [www.ninco.com](http://www.ninco.com).

CE 0678



MADE IN CHINA

**NINCO4RC**

is brand of NINCO DESARROLLOS S.L.

Ctra. de l'Hospitalet 32

08940 Cornellà Barcelona Spain

CIF B-60307725

